



# MD-200 User Manual

Mitchell **Diagnos**tics

Powered by  **BOSCH**

en User Manual

## Technical Support

1-800-533-6127

For technical questions on your product, contact (800) 533-6127, and select the option for technical support.

For assistance with internet or wireless connectivity, contact (800) 533-6127, and select the option for connectivity.

or email [tech@otctools.com](mailto:tech@otctools.com).

Copyright © 2018 Bosch Automotive Service Solutions Inc., All rights reserved.

The information, specifications, and illustrations in this guide are based on the latest information available at the time of printing. Bosch Automotive Service Solutions reserves the right to make changes at any time, without notice.

## Table of Contents

<b>Safety Definitions</b> .....	<b>2</b>	<b>Read DTCs Select Systems</b> .....	<b>28</b>
<b>General Information</b> .....	<b>4</b>	Ford/Lincoln/Mercury.....	30
Introduction .....	4	<b>Data Stream</b> .....	<b>32</b>
Handset .....	4	<b>Special Tests</b> .....	<b>36</b>
Handset Ports.....	5	<b>Diagnostic Information</b> .....	<b>38</b>
Software Descriptions .....	6	<b>Automated System Test</b> .....	<b>42</b>
Battery Charging .....	6	<b>Maintenance Tests</b> .....	<b>46</b>
Using the Handset.....	6	<b>Enhanced OBDII</b> .....	<b>47</b>
<b>Registration</b> .....	<b>7</b>	<b>Saved Diagnostic Data</b> .....	<b>47</b>
30 Day Trial.....	9	<b>Browser</b> .....	<b>48</b>
Demo.....	9	<b>Settings</b> .....	<b>48</b>
Provide Power to Scan Tool .....	10	<b>Customer Support</b> .....	<b>49</b>
Test Startup and Vehicle Connection.....	11		
<b>Settings</b> .....	<b>11</b>		
Application Settings .....	11		
Software Information .....	12		
Software Update.....	12		
Printer setup.....	12		
Subscription .....	12		
User Details.....	13		
Language .....	13		
<b>Selecting Vehicle</b> .....	<b>14</b>		
AutoID.....	14		
Manual Entry .....	14		
Recent .....	16		
Search by VIN .....	17		
<b>OBDII</b> .....	<b>18</b>		
Overview .....	18		
Diagnostic Functions .....	18		
Data Stream.....	18		
DTCs Modes.....	20		
Oxygen (O2) Sensors.....	21		
Non-Continuous Tests .....	22		
Special Tests.....	22		
Vehicle Info.....	23		
<b>Saved Diagnostic Data</b> .....	<b>24</b>		
<b>Browser</b> .....	<b>25</b>		
<b>Heavy Duty</b> .....	<b>26</b>		
<b>Read DTCs All Systems</b> .....	<b>27</b>		

## Safety Definitions

Follow all DANGER, WARNING, and IMPORTANT messages. These safety messages are defined as follows:

**▲ DANGER or WARNING:** Risk of bodily harm and/or possible loss of life.

**IMPORTANT:** The information demands special attention or risks damage to the vehicle or tool.

The safety messages cover situations of which Bosch Automotive Service Solutions is aware. Bosch Automotive Service Solutions cannot know, evaluate, or advise as to all of the possible hazards. You must be certain that any conditions or service procedures encountered do not jeopardize personal safety.

## Safety Precautions

**▲ DANGER:** When an engine is operating, keep the service area well ventilated or attach a building exhaust removal system to the engine exhaust system. Engines produce carbon monoxide, an odorless, poisonous gas that causes slower reaction time and can lead to serious personal injury or loss of life.

**▲ WARNING:** When working with hydraulic or fuel lines, be careful that liquids under pressure do not escape and create a dangerous condition. Use adequate ventilation and make sure there are no sparks or possibility of sparks that may ignite any vapor.

Wear an American National Standards Institute (ANSI) approved eye shield when testing or repairing vehicles.

Objects propelled by whirling engine components or pressurized liquids escaping may cause personal injury.

Set the parking brake and block the wheels before testing or repairing a vehicle. It is especially important to block the wheels on front-wheel drive vehicles because the parking brake does not hold the drive wheels.

Do not drive the vehicle and operate the software at the same time.

Maintain adequate clearance around moving components or belts during testing.

Moving components and belts can catch loose clothing, body parts, or test equipment and cause serious damage or personal injury.

Automotive batteries contain sulfuric acid and produce explosive gases that can result in serious injury ignition of gases, keep lit cigarettes, sparks, flames, and other ignition sources away from the battery at all times.

Refer to the service manual for the vehicle being serviced. Adhere to all diagnostic procedures and precautions Failure to do so could result in personal injury or otherwise unneeded repairs.

Use only specially designed replacement parts (brake hoses and lines) for ABS equipped vehicles.

After bleeding the brake system, check the brake pedal for excessive travel or a spongy feel. Bleed again if either condition is present.

When installing transmitting devices (Citizen Band radio, telephone, etc) on ABS-equipped vehicles, do not locate the antenna near the ABS control unit or any other control unit.

This equipment has been tested and found to comply with the limits for a Class B digital device, pursuant to Part 15 of the FCC Rules. These limits are designed to provide reasonable protection against harmful interference in a residential installation. This equipment generates and radiates radio frequency energy and, if not installed and used in accordance with the instructions, may cause harmful interference to radio communications.

To reduce risk of injury, charge only Bosch Automotive Service Solutions rechargeable batteries for the handset product with the supplied charger. Other types of batteries may burst causing injury to persons and property damage.

Use of an attachment not recommended or sold by the battery charger manufacturer may result in fire, electric shock, or personal injury.

Do not operate the tool with a damaged cord or connector. Replace damaged cords and connectors immediately.

Do not operate the charger if it has received a sharp blow, been dropped, or otherwise damaged in any way. Take the charger to a qualified service person.

Do not disassemble the charger. Take the charger to a qualified service person if service or repair is necessary. Incorrect reassembly may result in electric shock or fire. Unplug charger before attempting any maintenance or cleaning. Turning off controls will not reduce this risk.

To prevent possible hearing damage, avoid using the tool at high volume levels for long periods.

Do not expose tool or charger to rain, moisture, or snow.

Verify that cords are located where they will not be stepped on, tripped over, or otherwise become a safety hazard or subjected to damage or stress.

Use only batteries that are approved for use with this tool. Use of other types may increase the risk of fire or explosion.

Do not carry a battery in your pocket, purse, or other container where metal objects (such as car keys or paper clips) could short-circuit the battery terminals. The resulting excessive current flow can cause extremely high temperatures and may result in damage to the battery pack or cause fire or burns.

The battery poses a burn hazard if you handle it improperly. Do not disassemble it. Handle a damaged or leaking battery with extreme care. If the battery is damaged, electrolyte may leak from the cells and may cause personal injury.

Keep the battery away from children.

Do not store or leave your tool or battery near a heat source such as a radiator, fireplace, stove, electric heater, or other heat-generating appliance or otherwise expose it to temperatures in excess of 140 °F (60°C). When heated to excessive temperatures, battery cells could explode or vent, posing a risk of fire.

Do not dispose of your tool's battery in a fire or with normal household waste. Battery cells may explode. Discard a used battery according to the manufacturer's instructions or contact your local waste disposal agency for disposal instructions. Dispose of a spent or damaged battery promptly.

 **IMPORTANT:** To avoid damage or generation of false data, make sure the vehicle battery is fully charged and the connection to the vehicle Data Link Connector (DLC) is clean and secure.

Do not place the tool on the distributor of a vehicle. Strong electromagnetic interference can damage the tool.

Never disconnect or reconnect any electrical connector while the ignition is on. Powertrain Control Module (PCM) damage may result.

# General Information

## Introduction

ss01711

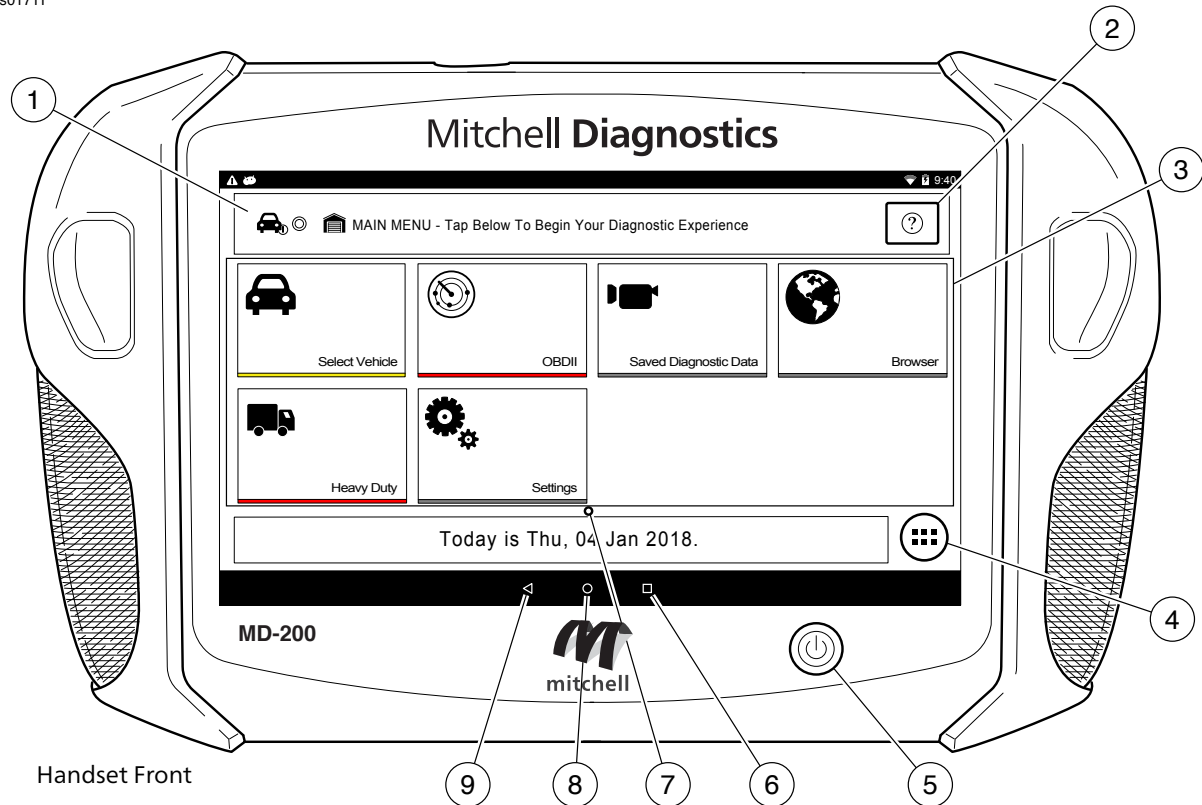

### 1. Vehicle Identification Window

- Where vehicle information is displayed.

### 2. Navigation Help button

### 3. Main Menu Functions

- Select Vehicle allows you to manually choose the vehicle, AutoID to automatically identify the vehicle or enter the VIN.
- OBDII (also referred to as Generic OBDII) Provides limited engine control and monitors the diagnostic control network of the vehicle.
- Saved Diagnostic Data allows the user to view previously run and saved DTC reads, All System DTC scan, and Automated System Test scans and data stream recordings.
- Browser Fast Touch™ sites and internet.
- Heavy Duty allows the user to read Heavy Duty
- Diagnostic information.
- Settings change settings of the tool.

### 4. Android Applications Button

- Displays the Apps screen.

### 5. Power Button

- Press to power ON handset or if running press to access menu to: Power Down.

### 6. Recent apps button

- Opens a list of thumbnail images of currently running apps.

### 7. Page indicator

- Displays the page currently being displayed.

### 8. Home Button

- Displays the Main Menu screen.

### 9. Back Button

- Returns to the previous screen or option.

## Handset

The handset is a ruggedized touchscreen tablet equipped with the Android operating system. The power button is located on the lower center front of the Handset.

ss01715

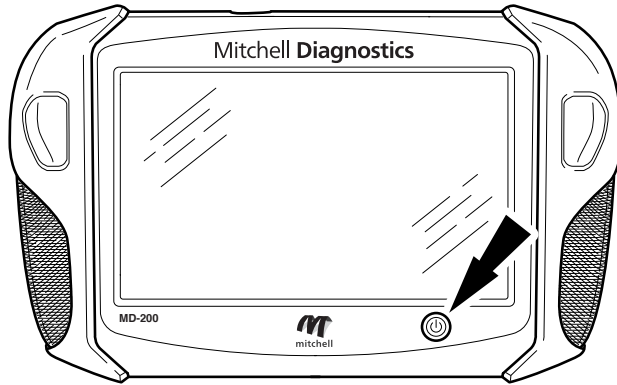

Handset Power Button

## Power Button Functions

The power button has four functions

- a. ON: Press the power button to turn the handset on.
- b. OFF: Press and release the power button. A pop up window will appear to shut down the handset.
- c. ON: If the screen times out or is in standby mode, press and release the power button to wake up the handset. Turn ON: With tool off, press to turn ON
- d. OFF: Press the power button and hold for 5 seconds to turn the handset off completely (not recommended).

## Handset Ports

ss01712

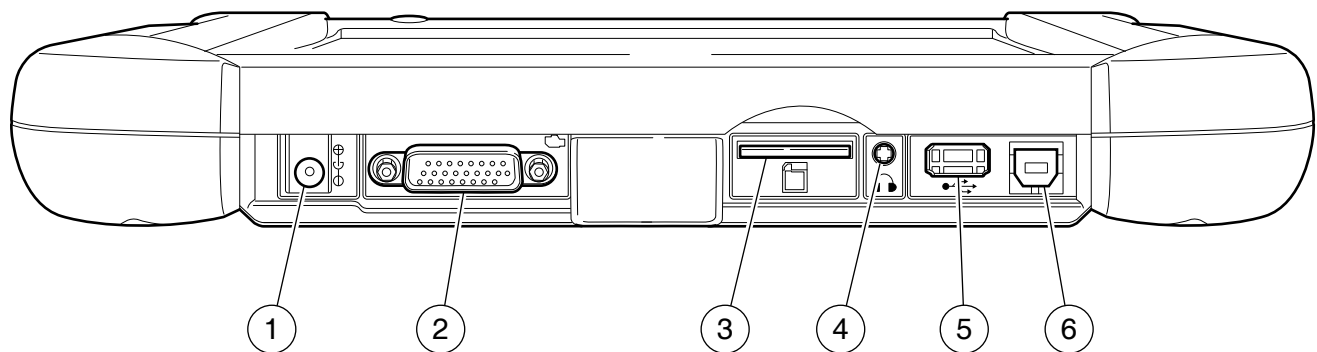

Handset Ports

1. Power port
2. DLC cable Port
3. SD card slot
4. Audio out port (3.5mm)
5. USB Type "A" port
  - Print to or store data as needed
  - Connect add-on hardware
  - USB Drive (optional) USB Type "A" port
6. USB Type "B" port

## Software Descriptions

### Handset Software

The handset comes with the diagnostic software pre-loaded.

The first time the handset is powered up, the user needs to accept the license agreement. Then, the user will have three choices:

- Register Now: Unlocks all functions of handset.
- Trial mode: Unlocks all functions for 30 days.
- Demo Mode: Displays what functions may look like.

Periodically, updates will become available and the user will be notified by an icon on the screen. To update the handset, there must be Wi-Fi connection available.

## Software Applications

### Overview

The handset allows users to diagnose problems on a wide variety of vehicles (from electric to heavy duty vehicles). Users are able to perform common service procedures, maintenance tests, and special tests to find deficiencies with vehicle systems or components.

The handset will display DTCs from OBDI or OBDII systems. Real-time sensor data can be viewed in data stream mode. The user can also obtain diagnostic information regarding repairs.

Browser mode allows the user to connect to the internet to find websites that may help with the repair of the vehicle. The handset comes with wireless communication for ease of use and on-screen help when desired.

## Battery Charging

Connect the handset to AC power and fully charge the battery.

ss01714

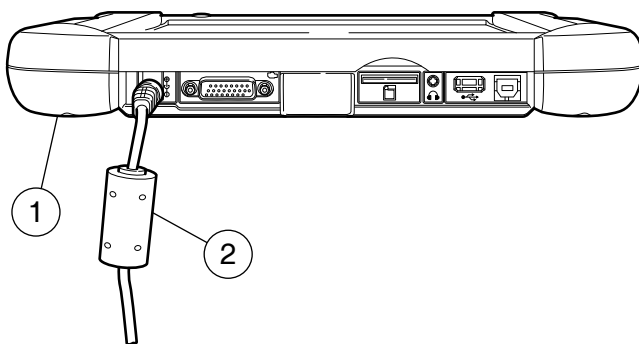

### Power Port

1. Handset
2. AC Power cord

When the handset is turned on, the level of battery charge is indicated in the upper right corner of the screen.

*NOTE: The tool can be used while charging. The battery can also be charged using the 15 volt power supply provided with the kit.*

## Using the handset

There are three options for use.

- Register Now: It is recommended to register for full functionality of tool and tech support.
- Trial Mode: This allows use of the handset for 30 days before it must be registered. If the 30 day trial period is over before it is registered, the handset functions will be locked out. At that time, register now or demo mode will need to be entered.
- Demo Mode: This mode demonstrates the functions by displaying random data.

ss01715

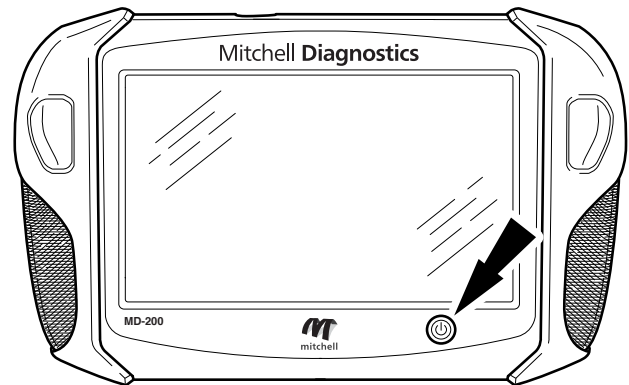

1. Press the power button to turn on the handset.

ss01719

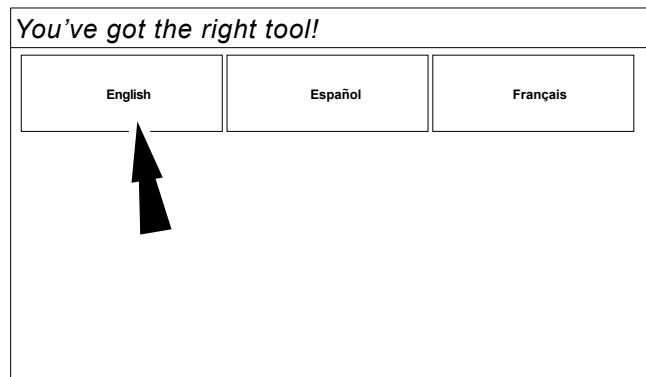

2. Select a language.



## Registration

It is important to register the handset right away. To register, it will need a Wi-Fi internet connection. To connect to Wi-Fi, refer to steps 2 through 6. Register now enables the unit. Register later causes the device to go into a 30-day trial mode. Demo Mode is for training and demonstration purposes only, it cannot communicate with a vehicle. Demo Mode will use sample data.

1. Select Register my Device Now.
2. Read and accept the user agreement.

ss01720

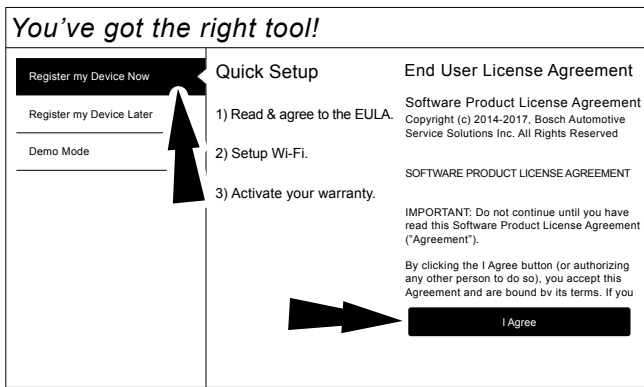

3. Select the correct Time Zone.

ss02825

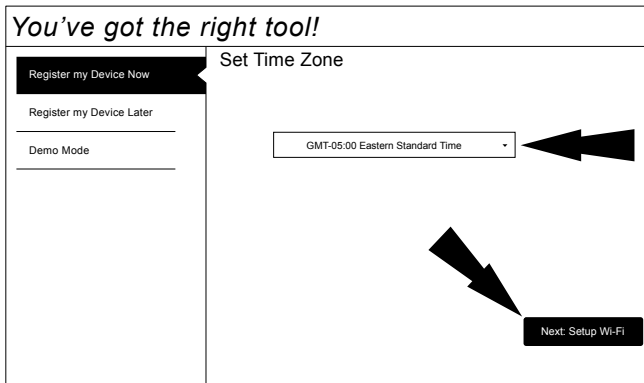

4. Enable Wi-Fi and select Next

ss02665

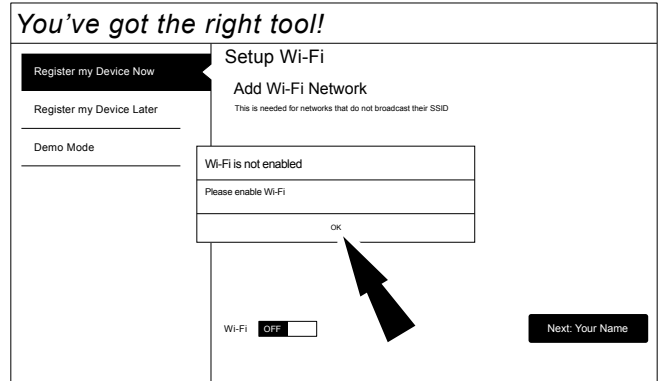

Note: Wi-Fi Must be ON. If Wi-Fi is OFF slide the Wi-Fi switch to the ON position and follow the prompts on the screen.

ss02666

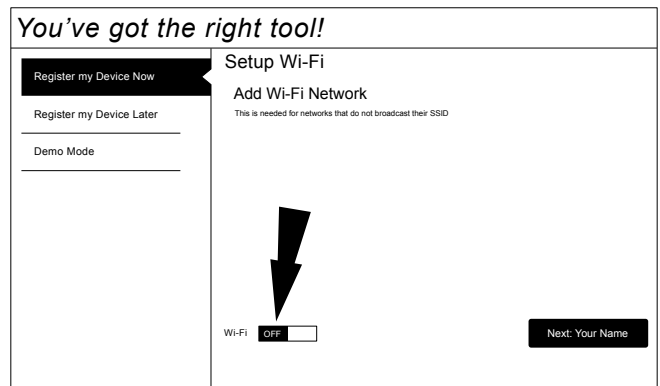

5. Select a network and select Next

ss01721

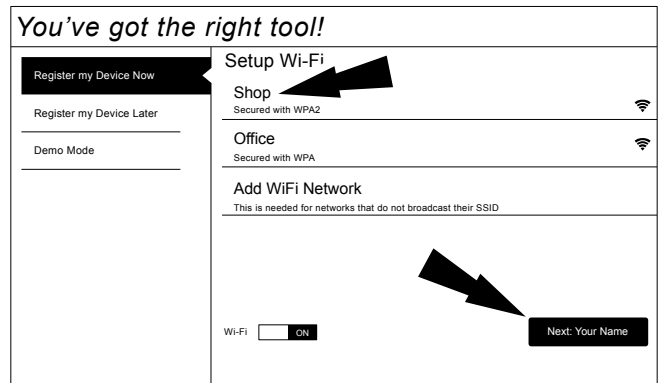

6. If a Network password is required the Android

Wi-Fi screen will be displayed. Follow the prompts on the screen.

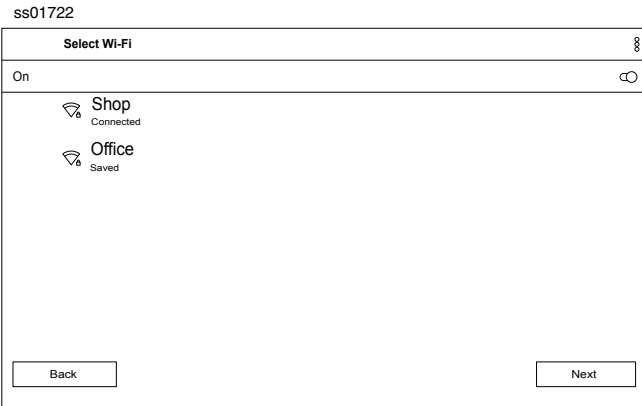

7. If an internet connection could not be established, follow the prompts on the screen and try again.

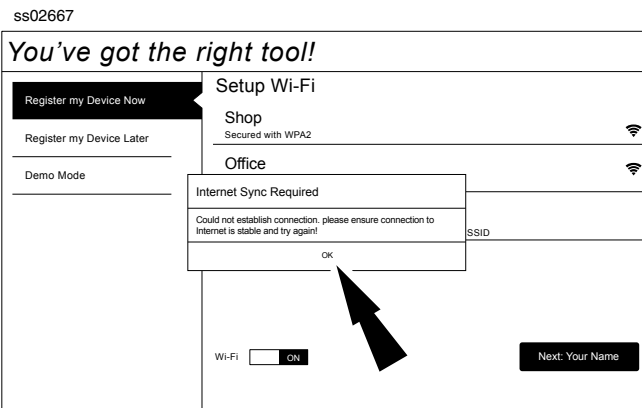

8. Enter your Name. Follow the prompts on the screen to activate warranty.

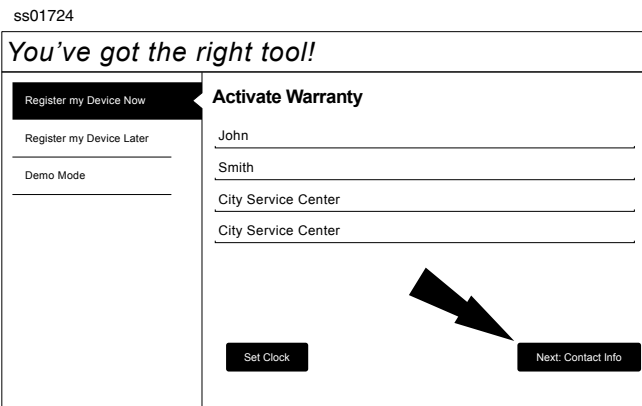

9. Enter contact information. Follow the prompts on the screen.

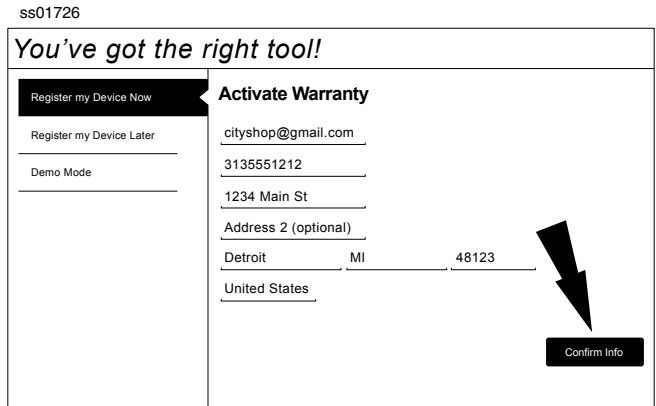

10. Confirm information. Follow the prompts on the screen and activate warranty.



11. Setup Printer. This can be completed later by going to Settings

ss02663

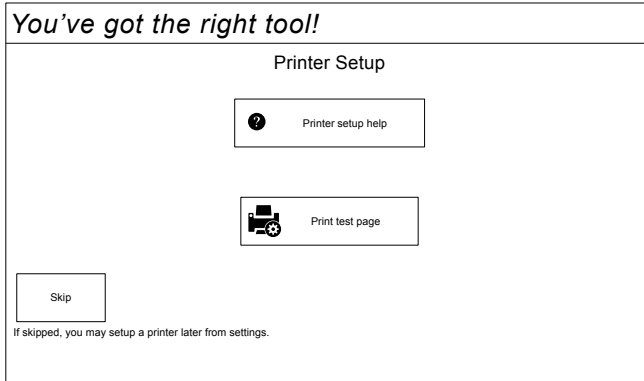

**12. Follow the prompts on the screen.**

ss02664

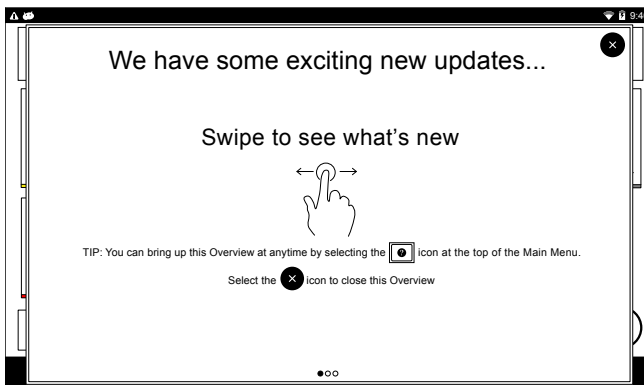

**13. MD-200 is ready to use.**

ss01728

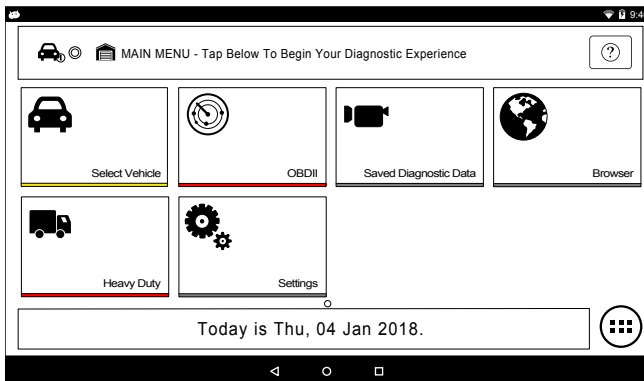

**30 Day Trial**

1. Select Register my Device Later for 30 days of full use of the tool before registration is required. If the handset is not registered within the 30 day trial period, after 30 days it will only function in Demo Mode.

ss01823

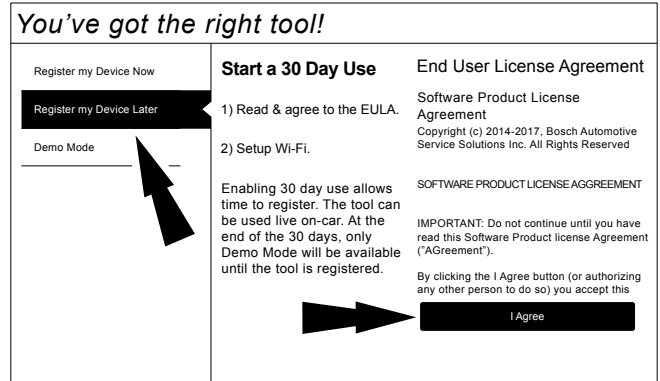

**1. MD-200 is ready to use.**

ss01824

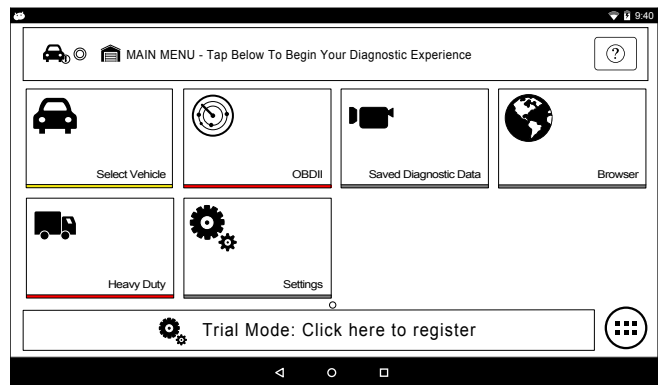

**Demo**

**1. Select Demo mode**

ss01825

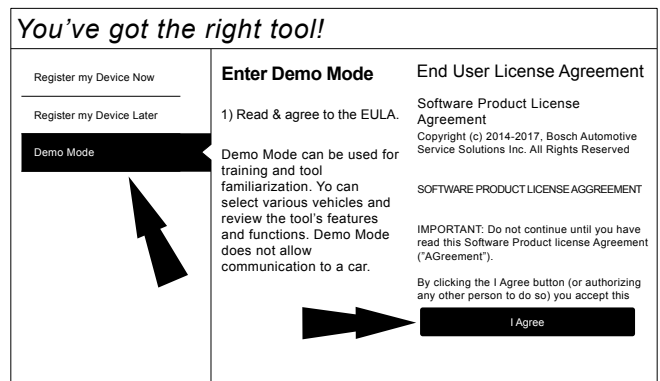

**2. MD-200 is ready to use.**

ss01826

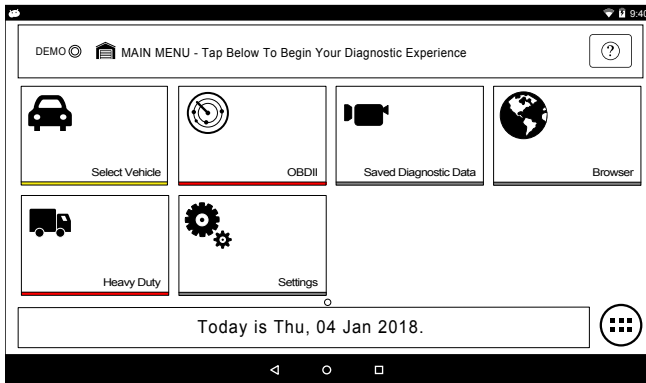

## Provide Power to Scan Tool

ss01716

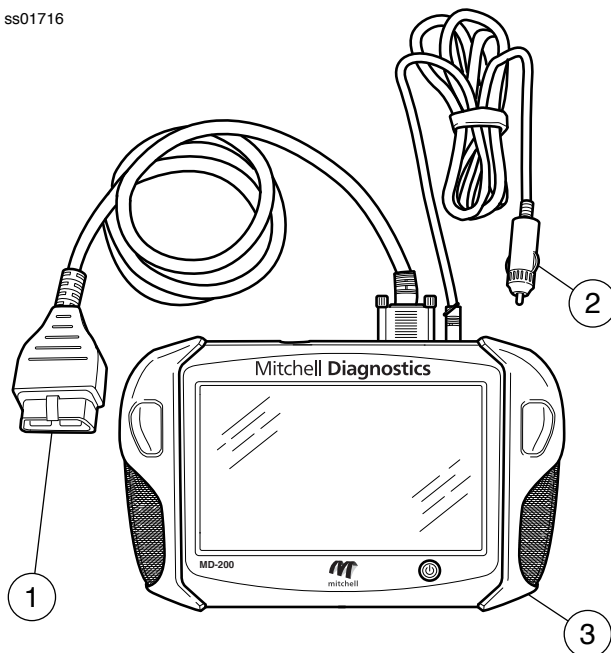

Scan Tool Cable Connections

1. OBD II / DLC cable
2. 12 volt power cable (Use with vehicles that do not supply power through DLC)
3. Scan tool

### Power via vehicle DLC

1. Connect the OBD II / DLC cable to the scan tool.
2. Connect the OBD II / DLC cable to the DLC on vehicle. Located within 18 inches (45.7 cm) of steering wheel. Typically located on the driver's side, under dash.

3. Turn ignition ON.

### Non-powered vehicle DLC setup

Some vehicles do not supply power through DLC. In this case use the following procedure.

1. Connect OBD II / DLC cable to scan tool.
2. Connect OBD II / DLC cable to DLC on vehicle. Typically located on the driver's side under the dash.
3. Connect the 12 volt power cable to the scan tool power port.
4. Connect the 12 volt power connector to the vehicle power outlet
5. Turn ignition ON.

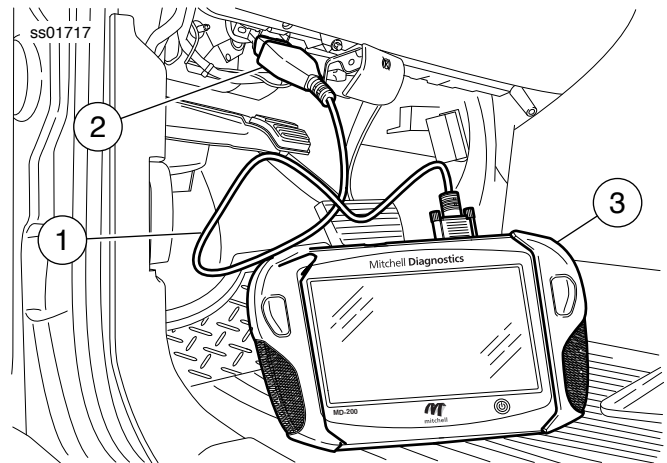

Scan Tool Connected to Vehicle

1. OBDII/DLC Cable
2. DLC
3. Scan Tool

## Turning off handset:

ss01713

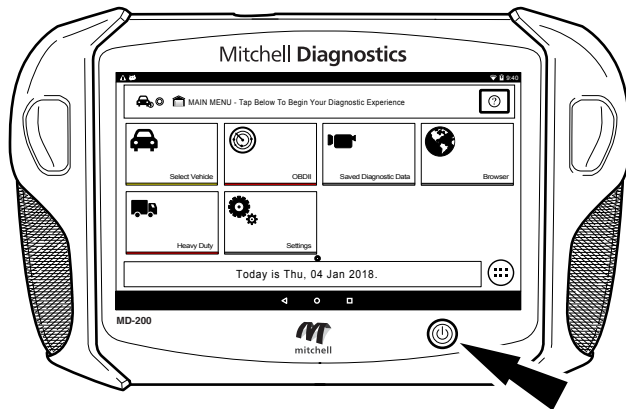

1. Press and release the power button.

ss02856

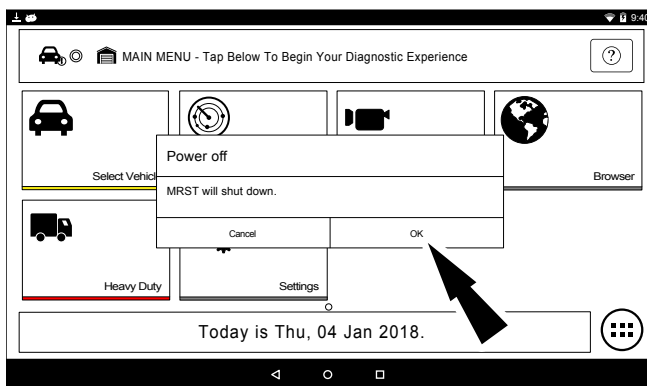

2. Select OK. The tool will now shutdown.

## Test Startup and Vehicle Connection

1. Turn ON the handset.
2. Connect the OBDII/DLC cable to the scan tool.
3. Connect the OBDII/DLC cable to the DLC on the vehicle.
4. Turn the ignition ON, but keep the engine OFF (KOEO).
5. Select vehicle from the Main Menu screen.
6. Enter the vehicle information one of two ways:
  - AutoID
  - Manual entry
7. From the Vehicle selected screen, select any diagnostic function.

## Settings

Settings allow the user to make adjustments to the following:

- Applications
- Software information
- Software update
- Printer Setup
- Subscriptions
- User Detail
- Language
- Direct-Hit
- Service
- Report Options

ss02852

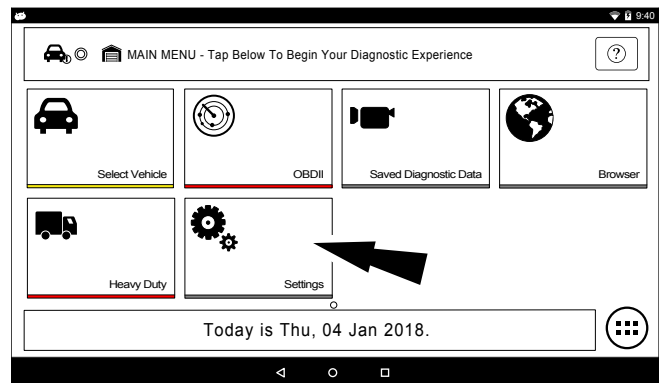

1. Select Settings from the Main Menu.

## Application Settings

From the Settings screen select Application Settings. Follow the prompts on the screen to make changes to the following:

- Demo Mode
  - Turn Demo mode ON or OFF
- Units of measure
  - Switch between Standard or Metric
- Use TPR
  - Enable TRP
- Data Steam Scroll Options
  - Select scrolling options

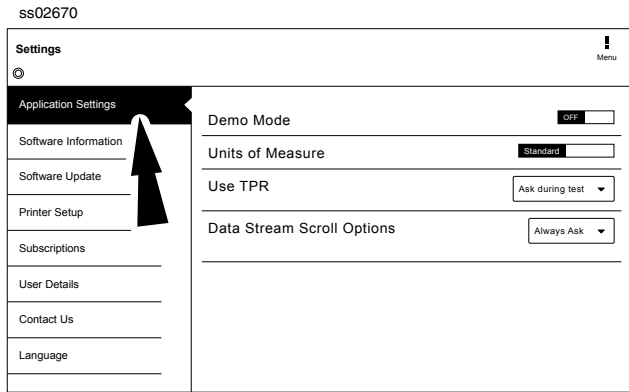

### Software Information

From the Settings screen select Software Information. The current software versions will be displayed.

Select View Open Source Software Details to view more in-depth information.

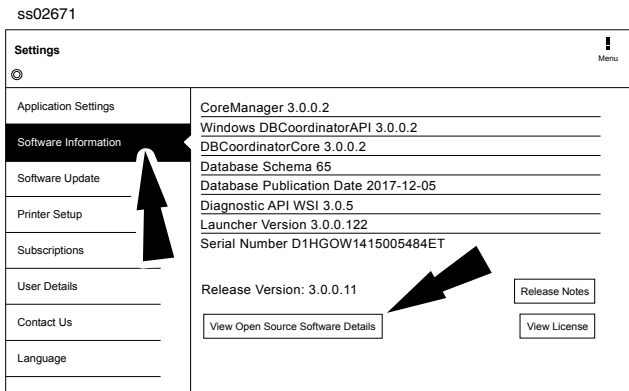

### Software Update

From the Settings screen select Software Update.

- Manually check for updates.
- Automatic download.

*NOTE: Active internet connection is required for this function.*

If an update is available follow the prompts on the screen to update the handset. Downloading the software will occur in the background and varies with Wi-Fi connection speed and quality. Installing the software can take up to 45 minutes. Please be sure to have your handset fully charged and allow sufficient time for the installation.

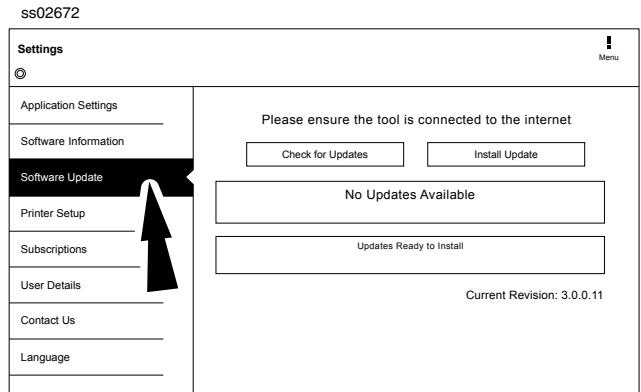

### Printer setup

1. Ensure device is connected to internet and that network has unrestricted access to Google services.
2. Follow the prompts on the screen.

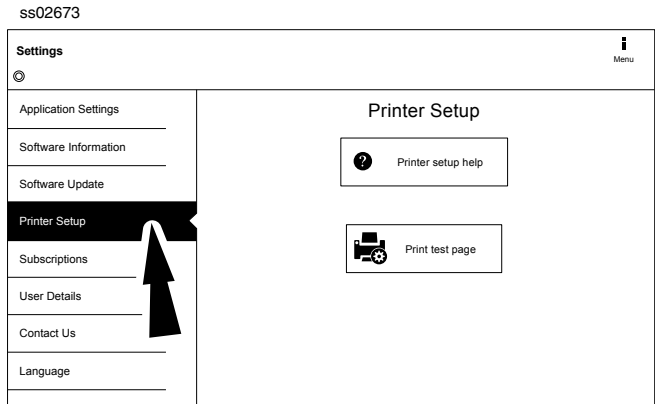

### Subscription

The tool must be registered to see this tab.

1. From the Settings screen select Subscription.
  - Heavy duty vehicle function is locked and must be unlocked.
  - Need to obtain subscription code.
  - After one year, the user will be required to renew the subscriptions to receive product updates.

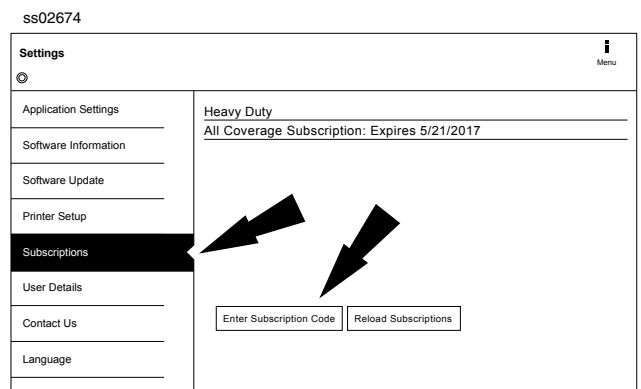

## 2. Select Enter Subscription Code.

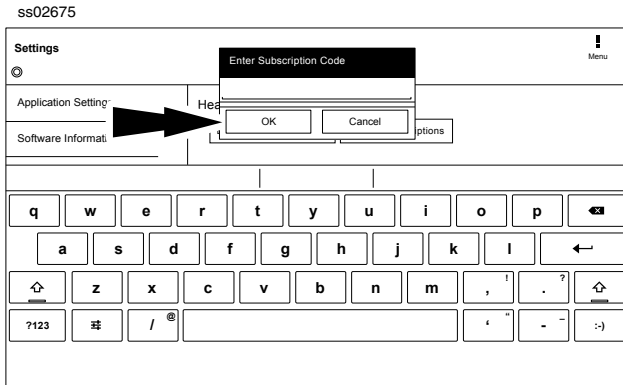

## 3. Enter Subscription Code and select OK.

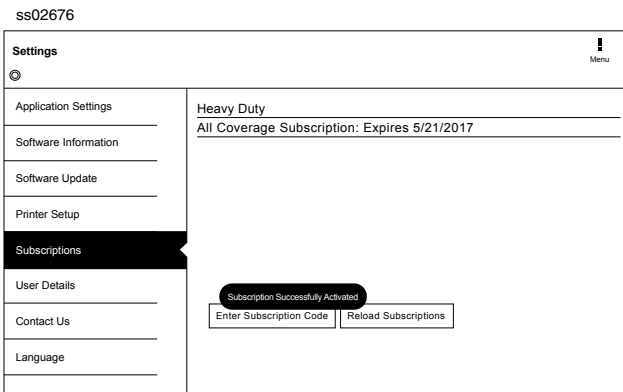

## User Details

### 1. From the Settings screen select User Details.

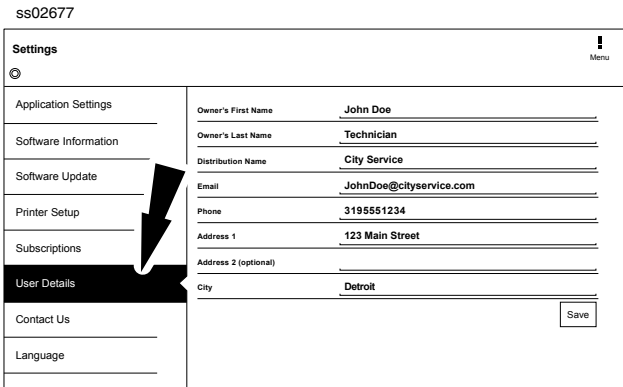

### 2. Select field to modify.

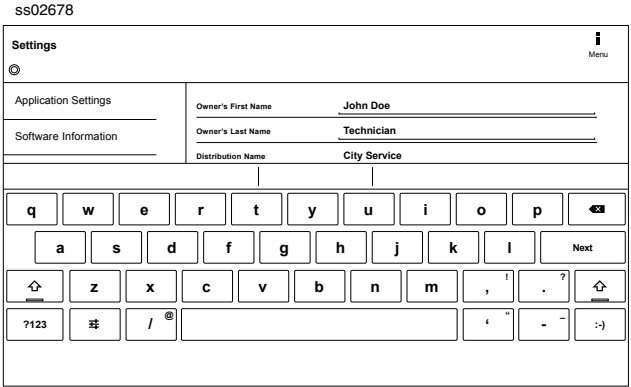

Note: The information saved in User Details will also update registration information.

## Language

1. From the Settings screen select Language
2. Follow the prompts on the screen
3. English
4. Spanish
5. French

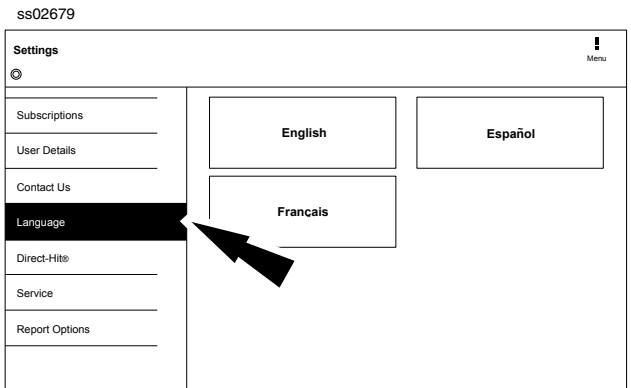

## Selecting Vehicle

**⚠ WARNING:** Before performing any diagnostic functions, refer to the Safety Precautions and Warnings provided by the vehicle manufacturer. In addition, follow any warnings and instructions provided on the handset.

ss02826

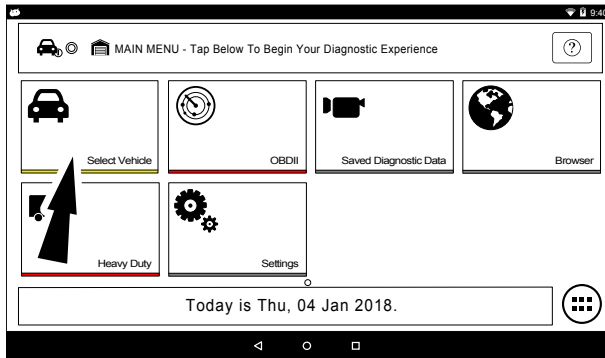

1. Select Vehicle from the Main Menu screen to manually choose the vehicle, AutoID to automatically identify the vehicle or enter the VIN.
2. Select the vehicle specification options on each screen until the complete vehicle information is entered.

### AutoID

AutoID uses the vehicle's Mode 9 VIN information, when available. Most vehicles from 2004 and newer support AutoID, but some other older vehicles may support Mode 9 too.

### AutoID Operation:

1. Handset must be on and connected to the vehicle.

ss02689

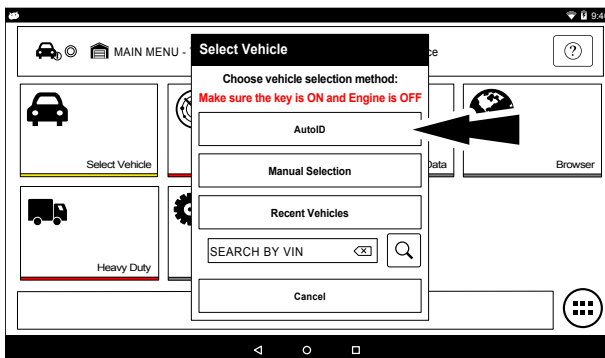

2. Select AutoID.
3. Once selected the handset will begin

communicating with the vehicle.

4. The vehicle must have the key on, engine off (KOEO).
5. Once the VIN is retrieved it is compared to the vehicle database.
6. If a match is found the vehicle selection information will be displayed on the screen.
7. Wait for AutoID to finish.

ss02710

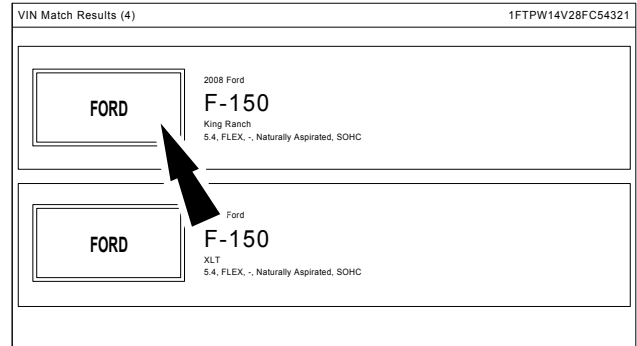

8. Select the desired vehicle from the list.

ss02835

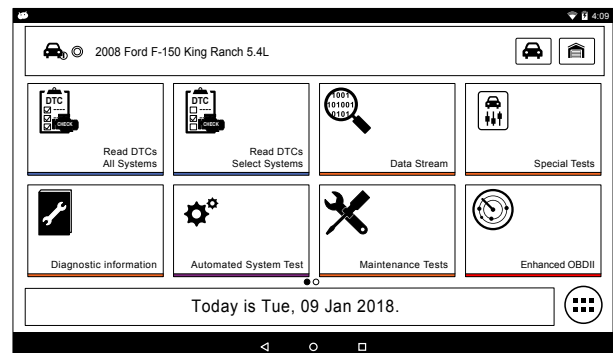

9. At this point vehicle entry will disappear and the user will be able to begin using diagnostic functions on the vehicle.



## Manual Entry

The handset must be turned on, and connected to the vehicle. Once those conditions are met, complete the following:

ss02826

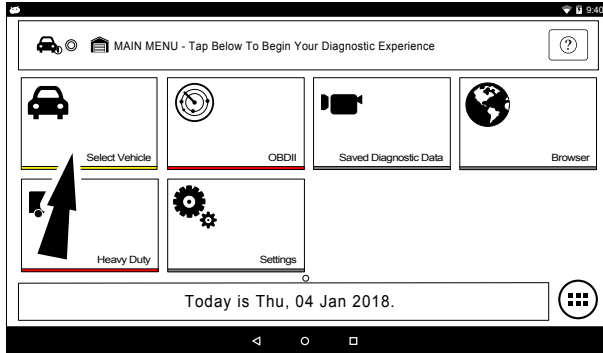

1. Select Vehicle.

ss02690

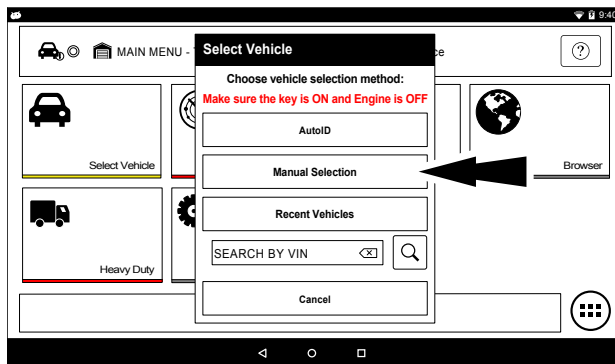

2. Select Manual Selection.

ss02711

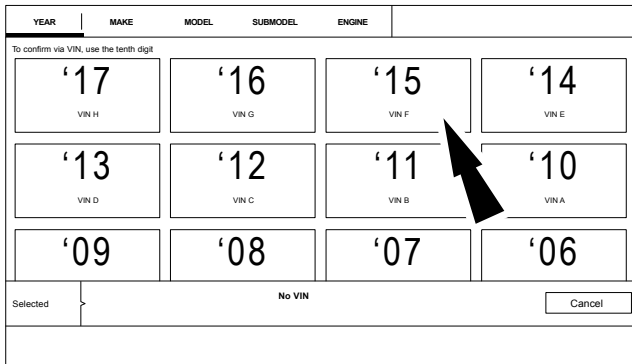

3. Select the model year of the vehicle.

ss02712

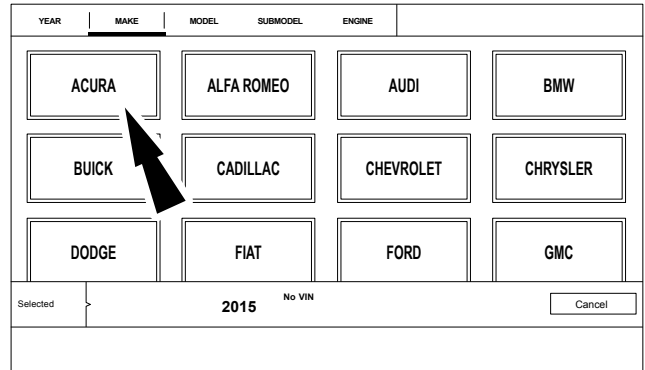

4. Select the make of vehicle.

ss02713

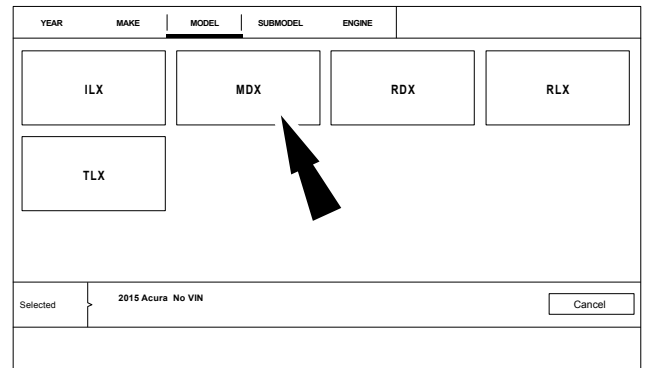

5. Select the model.

ss02714

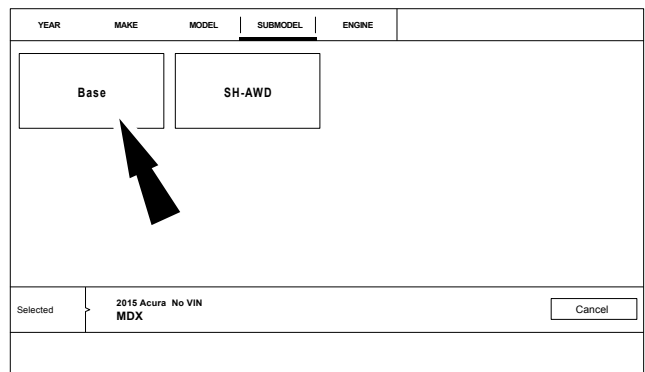

6. Select the sub-model (trim level).

ss02715

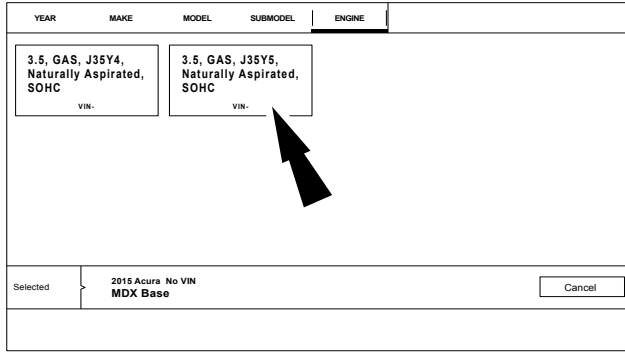

7. Select the engine.

Note: Some vehicles may not require this selection.

ss02836

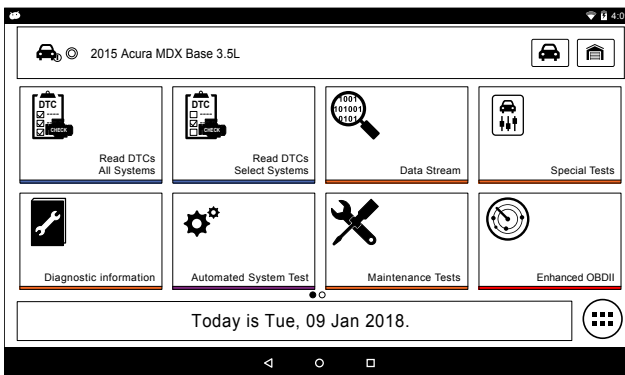

8. At this point vehicle entry will disappear and the user will be able to begin using diagnostic functions on the vehicle.

Recent

ss02826

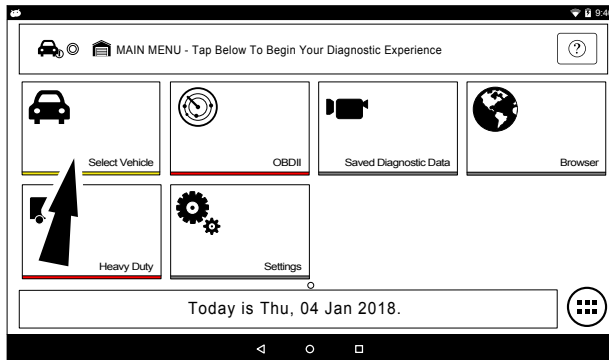

1. Select Vehicle.

ss02691

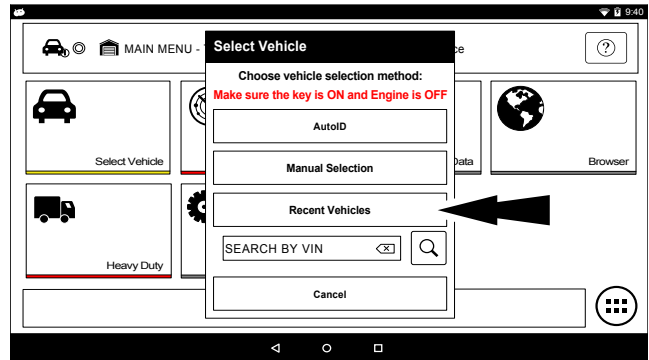

2. Select Recent Vehicles.

ss02716

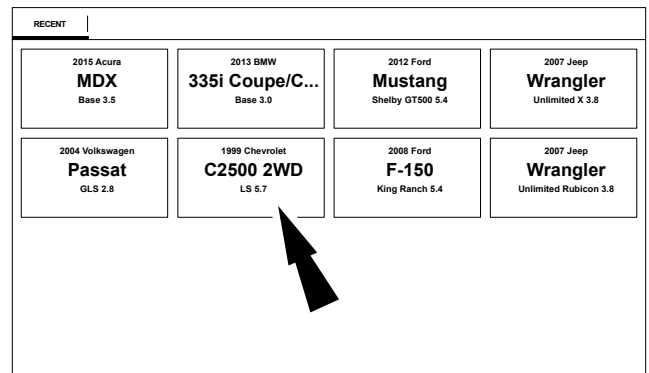

3. Press and hold a recent vehicle tile and select one of two choices:

- Set as current vehicle.
- Delete from reents.

4. Or just tap on the recent vehicle tile.

ss02837

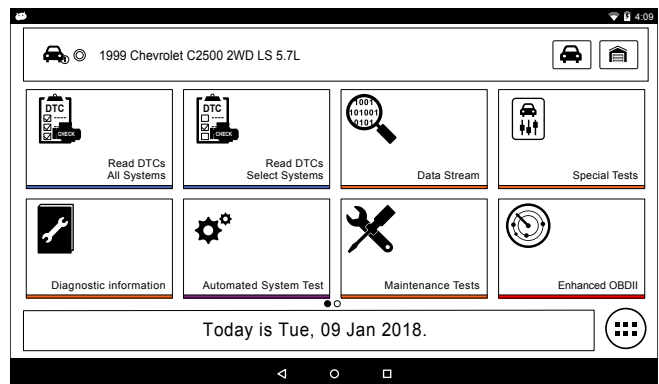

5. At this point vehicle entry will disappear and the user will be able to begin using diagnostic functions on the vehicle.

## Search by VIN

ss02826

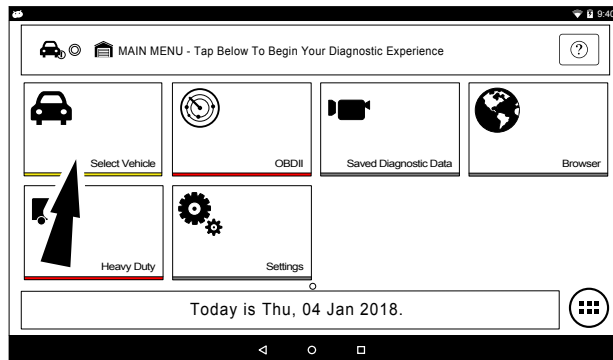

1. Select Vehicle.

ss02692

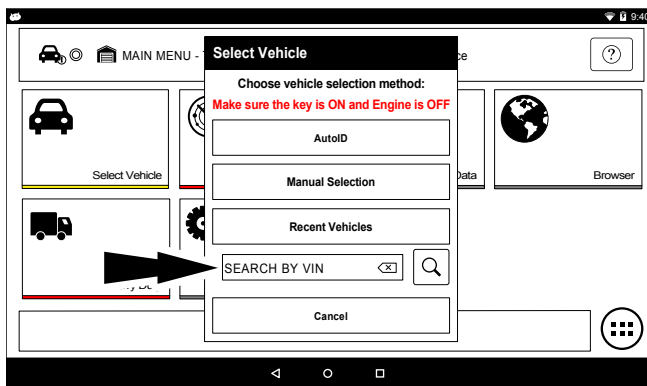

2. Select Search By VIN.

ss02848



3. Enter 17-digit VIN then OK.

ss02710

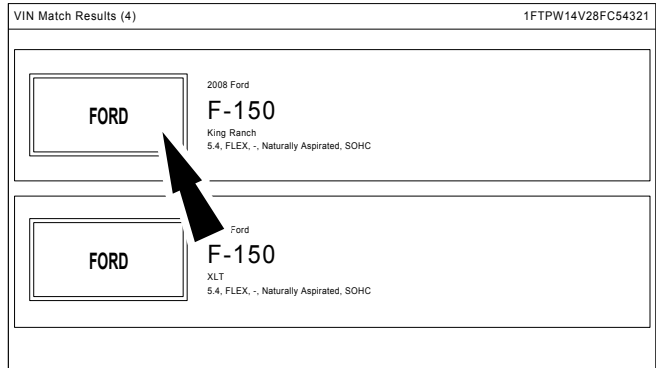

4. Select the desired vehicle from the list.

ss02835

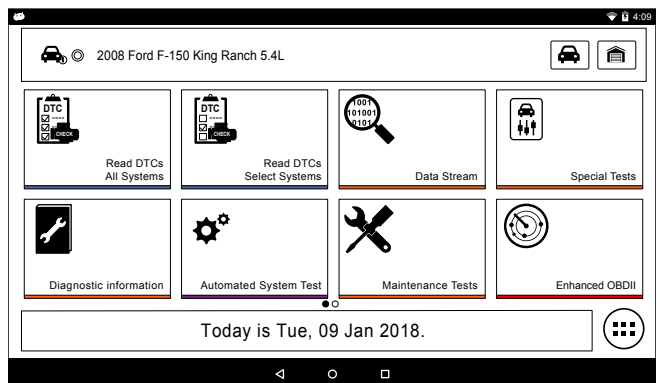

5. At this point vehicle entry will disappear and the user will be able to begin using diagnostic functions on the vehicle.

## OBDII

### Overview

OBDII (also referred to as Generic OBDII) provides limited engine control and monitors the diagnostic control network of the vehicle. When a fault in the control network occurs, a DTC is recorded in the vehicle computer. This system is not vehicle specific so it is NOT necessary to select the vehicle to run a generic test.

*NOTE: Enhanced OBDII may be selected from the Diagnostics menu with a vehicle loaded for more specific Mode 6 test information.*

## Diagnostic Functions

ss02827

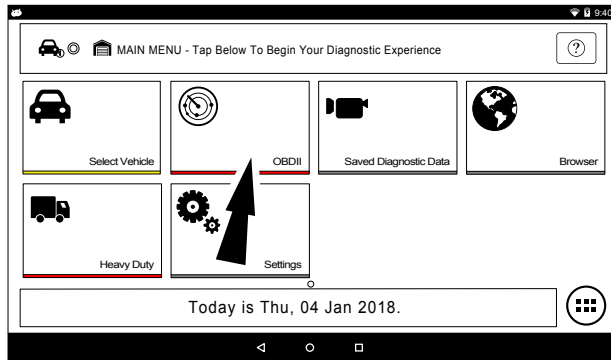

1. Select OBD-II from the Main Menu screen.
2. Follow the prompts on the screen.

### Readiness Monitors

Mode 1 displays available monitor information.

The OBDII system has a series of systems that run self-tests. These systems or components have to be made ready by either turning on the ignition or manipulating the system in some other manner. This is called drive cycle.

Each system requires specific vehicle drive cycle and operating requirements to take place before the monitor self-check will run. OBDII systems require one monitor for current systems, or two monitors for older systems, are ready before testing can begin.

If the system is ready, no further action is required.

If the system is not ready, a drive cycle may need to be performed for that system.

Use the following procedure to verify the system is ready to be monitored.

ss02718

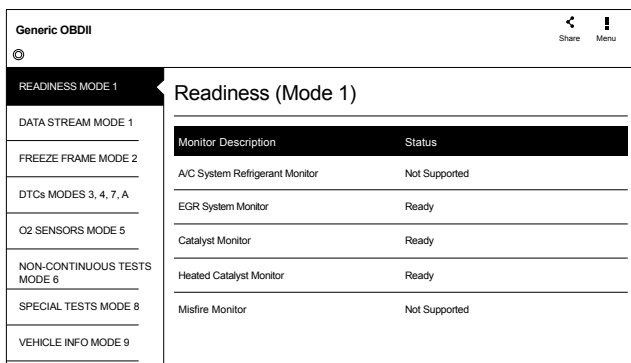

1. View the readiness table to verify system status.

- Ready: No further action is required.
- Not ready: Further action is required. Drive

Cycle needs to be performed.

- Monitor not supported: Data is not supported on vehicle.

Readiness Mode Button Definitions	
	Menu Button Tapping the Menu button displays a pop-up link that takes the user to more buttons.
	View Help Selecting View Help will open an online user manual.
	Use Metric Units Selecting Metric Units will switch from English/Standard Units to Metric Units
	Use English/Standard Units Selecting English/Standard Units will switch from Metric Units to English/Standard Units.
	Take Screen Capture Selecting Take Screen Capture will save a copy of the current open screen.

### Data Stream

Mode 1 views live vehicle sensor data.

The data stream function shows live sensor and solenoid data streaming from the vehicle's electronic control unit (ECU).

ss02719

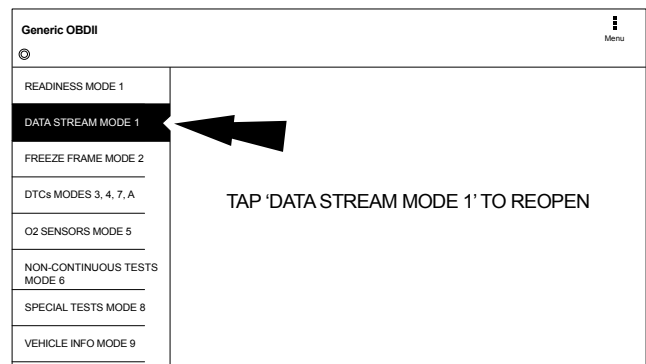

1. Select Data Stream Mode 1 from the Generic OBDII screen.

ss02420

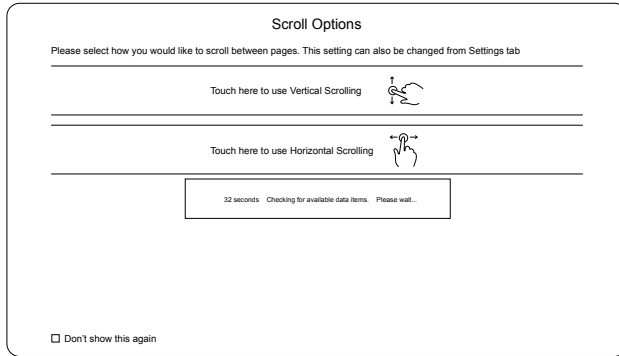

2. Select scrolling preference.

ss02720

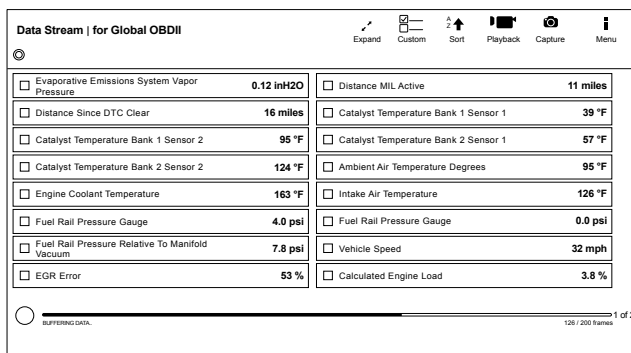

3. Follow the prompts on the screen.

Data Stream Button Definitions	
	<p><b>Enlarge Screen View Function</b> To view the data in the enlarge view, press the Enlarge button.</p>
	<p><b>Select Function:</b></p> <ol style="list-style-type: none"> <li>1. Choose only the data you want to view by checking the box in front of each desired data item.</li> <li>2. Select the Sort button.</li> </ol>
	<p><b>Sort Function:</b></p> <ul style="list-style-type: none"> <li>• Select Sort to sort data items.</li> <li>• Data may be sorted alphabetically, by graph, or by selection (checkbox checked).</li> <li>• Sorting data items will reset the timeline frame counter, so sort these items before recording data. If sorting data while recording the recording will have a period of time where there is no data available.</li> </ul>

Data Stream Button Definitions	
	<p><b>Recording:</b></p> <ul style="list-style-type: none"> <li>• Select Recordings to view previously recorded data streams.</li> <li>• Recordings are listed from newest to oldest. When the folder is full, the newest recording pushes the oldest one out of the list. Currently, there is no way to manually delete recordings.</li> <li>• To view recordings, select the Recordings button near the top of the display.</li> <li>• Select the desired recording.</li> </ul>
	<p><b>Take Screen Capture</b> Selecting Take Screen Capture will save a copy of the current open screen.</p>
	<p><b>Menu Button</b> Tapping the Menu button displays a pop-up link that takes the user to more buttons.</p>
	<p><b>Erase All Recordings.</b></p>
	<p><b>Clear All Data</b> Select Clear Data to clear displayed data stream. This function will reset the timeline frame counter and clear graphed data.</p>
	<p><b>Use Metric Units</b> Selecting Metric Units will switch from English/Standard Units to Metric Units.</p>
	<p><b>Use English/Standard Units</b> Selecting English/Standard Units will switch from Metric Units to English/Standard Units.</p>

## Freeze Frame

Mode 2 views data captured when a fault occurred. Freeze frame shows a data stream snapshot that was automatically recorded by the ECU when one or more DTCs occurred.

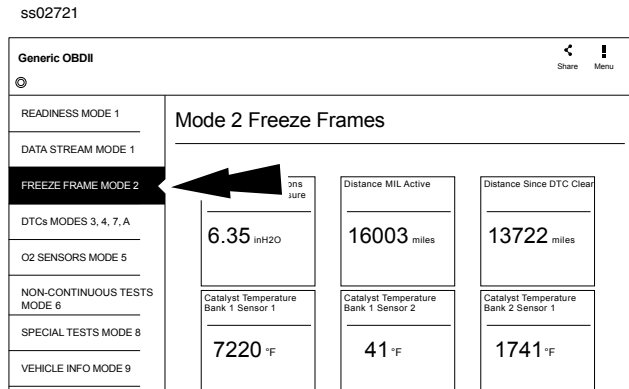

Freeze frame records each sensor's current information at the time a DTC sets. This feature could be used when diagnosing an intermittent condition that requires certain conditions are met before the fault is active.

*NOTE: DTCs are not always stored in Mode 2 freeze frame.*

Freeze Frame Button Definitions	
	Menu Button Tapping the Menu button displays a pop-up link that takes the user to more buttons.
	View Help Selecting View Help will open an online user manual.
	Use Metric Units Selecting Metric Units will switch from English/Standard Units to Metric Units.
	Use English/Standard Units Selecting English/Standard Units will switch from Metric Units to English/Standard Units.
	Take Screen Capture Selecting Take Screen Capture will save a copy of the current open screen.

## DTCs Modes

Modes 3, 4, 7, and A read and clear DTCs.

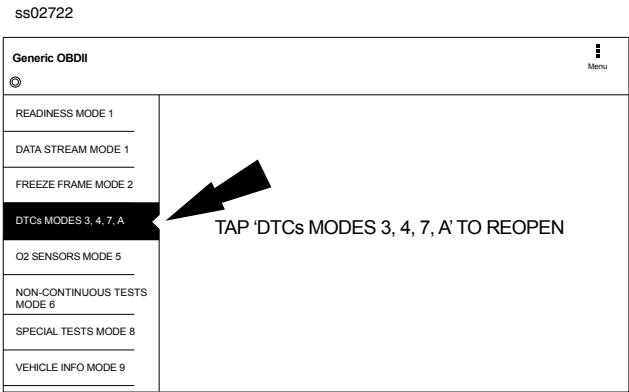

1. Select DTCs Modes from the Generic OBDII screen.

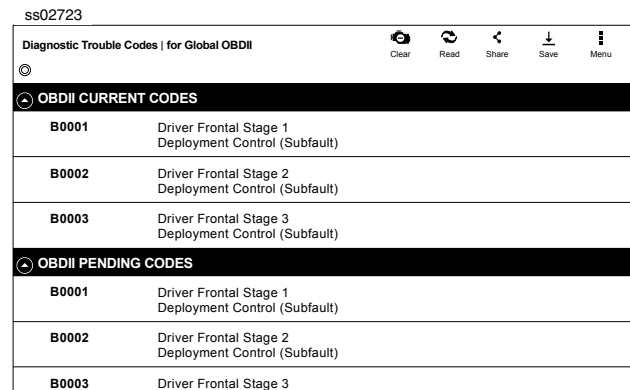

2. Use the buttons and follow the prompts on the screen.

## OBDII DTC Nomenclature

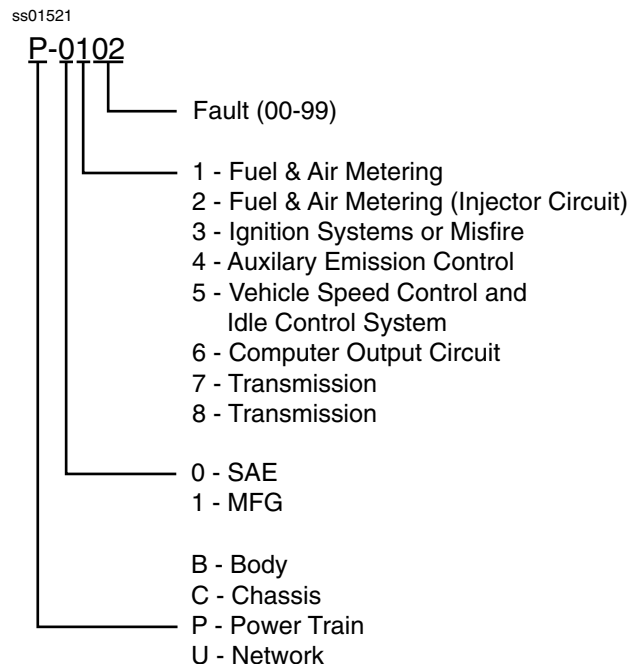

Example: P0102 Mass Air Flow Performance

### DTCs Modes 3, 4, 5, A Button Definitions

	<p><b>Clear DTCs Button</b> The Clear DTCs button is used to clear codes and remove all but permanent DTCs on the selected controller. To clear codes, complete the following: <b>NOTE:</b></p> <ul style="list-style-type: none"> <li>Clearing DTCs will erase current Mode 1 Readiness monitor information and require the user go through necessary drive cycles over again. So, if Mode 1 information needs to be reviewed, be sure to view it before clearing codes.</li> <li>If a code will not clear, turn the ignition off for at least 10 seconds; turn it back on to KOEO, then retry. Some controllers will go to sleep after a period of inactivity and prevent clearing DTCs. This key cycle may be needed when attempting to communicate with other controllers after a period of time on a different controller.</li> </ul>
	<p><b>Refresh DTCs Button</b> Tapping the Refresh button initiates a fresh scan of DTCs from the vehicle.</p>
	<p><b>Share DTCs Button</b> Tapping the Share button opens the app and initiates options. Depending on what's available at the time. Share a list containing all the DTCs set by email or Bluetooth or USB.</p>
	<p><b>Menu Button</b> Tapping the Menu button displays a pop-up link that takes the user to help content related to reading DTCs. <b>Note:</b> An active internet connection will be required.</p>
	<p><b>Use Metric Units</b> Selecting Metric Units will switch from English/Standard Units to Metric Units.</p>
	<p><b>Use English/Standard Units</b> Selecting English/Standard Units will switch from Metric Units to English/Standard Units.</p>
	<p><b>Take Screen Capture</b> Selecting Take Screen Capture will save a copy of the current open screen.</p>

## Oxygen (O2) Sensors

Mode 5 views O2 sensor monitor test results.

ss02724

Generic OBDII		Oxygen Sensor Tests (Mode 5)			
Description	Min	Value	Max	Units	
<b>Bank 1 Sensor 1</b>					
Maximum Sensor Voltage For Test Cycle	0.000	0.003	1.275	V	
Threshold Voltage	0.000	0.003	1.275	V	
High Sensor Voltage +/- or Switch Time Calculation	0.000	0.003	1.275	V	
Minimum Sensor Voltage For Test Cycle	0.000	0.003	1.275	V	

Mode 5 displays the average of the O2 sensor monitor test results measured over a period of time. The parameters of this measurement vary between manufacturers. It may be necessary to run the vehicle for a period of time to allow the O2 sensors to fully warm up and begin operating as intended.

### Oxygen (O2) Sensors Button Definitions

	<p><b>Menu Button</b> Tapping the Menu button displays a pop-up link that takes the user to more buttons.</p>
	<p><b>View Help</b> Selecting View Help will open an online user manual.</p>
	<p><b>Use Metric Units</b> Selecting Metric Units will switch from English/Standard Units to Metric Units.</p>
	<p><b>Use English/Standard Units</b> Selecting English/Standard Units will switch from Metric Units to English/Standard Units.</p>
	<p><b>Take Screen Capture</b> Selecting Take Screen Capture will save a copy of the current open screen.</p>

## Non-Continuous Tests

Mode 6 views onboard monitoring test results for noncontinuous monitor systems.

ss02725

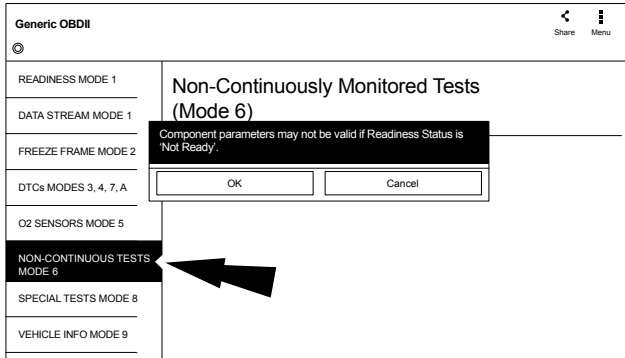

1. Select Non-Continuous Tests from the Generic OBDII screen.
2. Follow the prompts on the screen.

ss02726

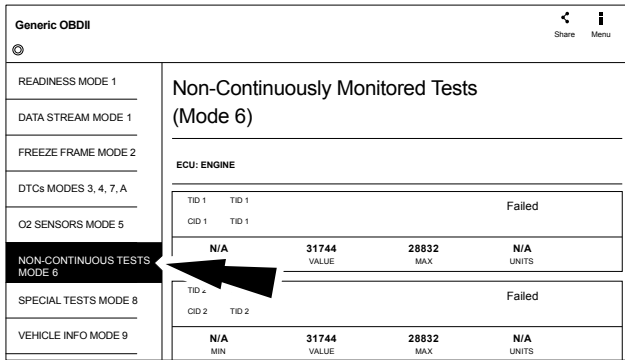

Non-Continuous Monitor Tests (Mode 6) are a pass/fail test. Some examples are certain EVAP tests, catalyst, and EGR. The following information is reported:

- ECU.
- TID (test identification) which indicates the system monitor.
- CID (component identification) which indicates the component tested and its test value.
- Minimum value, maximum value, and current value for each non-continuous monitor supported.
- Pass or fail test results.

Each vehicle manufacturer assigns a code number to their system monitors and components. Refer to the vehicle manufacturers Mode 6 code chart to determine the failure indicated by the TID and CID. If this chart is not available, run an automated system test (AST) from the DTC screen and select Mode 6. See Read DTCs section for more information regarding steps to complete that action.

Non-Continuous Tests Button Definitions	
	Menu Button Tapping the Menu button displays a pop-up link that takes the user to more buttons.
	View Help Selecting View Help will open an online user manual.
	Use Metric Units Selecting Metric Units will switch from English/Standard Units to Metric Units.
	Use English/Standard Units Selecting English/Standard Units will switch from Metric Units to English/Standard Units.
	Take Screen Capture Selecting Take Screen Capture will save a copy of the current open screen.

## Special Tests

Mode 8 controls the operation of an onboard system, test, or component which is typically the EVAP system or diesel particulate filter (DPF) test.

ss02727

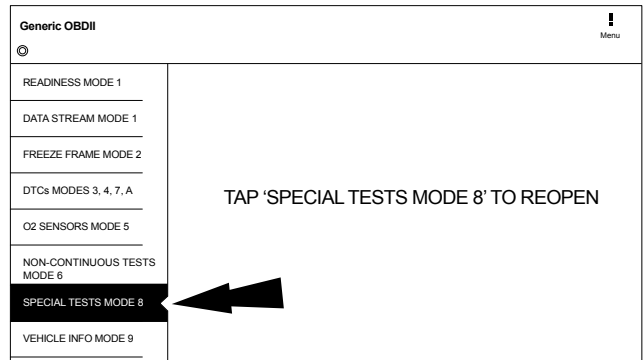

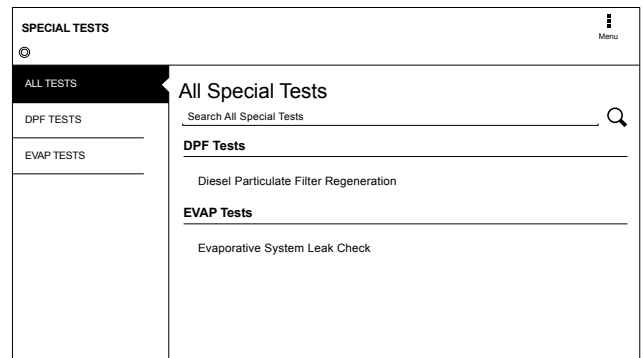

1. Select Special Tests from the Generic OBDII screen.

ss02728





When available, this selection will automatically take the user to the special test screen where the test group menu will be displayed. Make a selection to enter the test, then follow the on-screen prompts. Mode 8 will not be supported on all vehicles. If you wish to run an EVAP test on a vehicle that does not support Mode 8, enter vehicle specific mode and refer to the Special Tests section on how to run a special test.

Special Tests Button Definitions	
	Menu Button Tapping the Menu button displays a pop-up link that takes the user to more buttons.
	View Help Selecting View Help will open an online user manual.
	Use Metric Units Selecting Metric Units will switch from English/Standard Units to Metric Units.
	Use English/Standard Units Selecting English/Standard Units will switch from Metric Units to English/Standard Units.
	Take Screen Capture Selecting Take Screen Capture will save a copy of the current open screen.

## Vehicle Info

Mode 9 views Vehicle Identification Numbers (VINs), calibration ID(s), and verification number(s).

ss02729

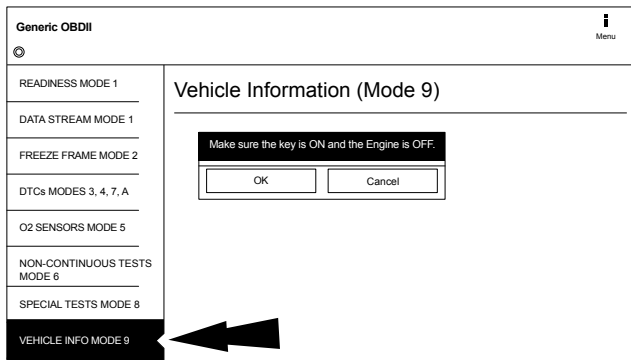

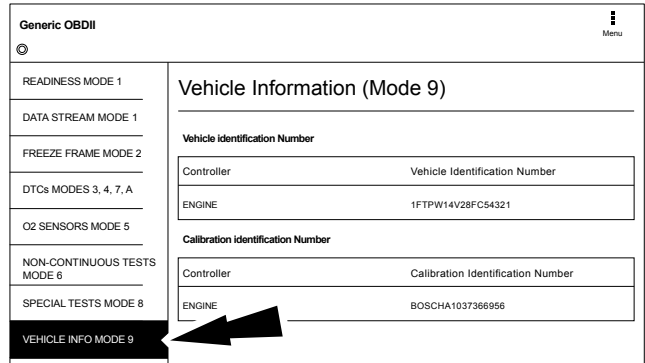

1. Select Vehicle Info from the Generic OBDII screen.
2. Follow the prompts on the screen.

ss02730



The 17 digit VIN provides information on the vehicle including year of manufacture, engine and possibly transmission type, vehicle body style, and color.

Mode 9 is not supported on older vehicles, so a visual check of the VIN through the windshield or on the door sticker would be required to obtain that VIN. Mode 9 is used on the tool to AutoID the vehicle and for calibration verification to see if a newer calibration is available for re-flashing the ECU.

Vehicle Info Button Definitions	
	Menu Button Tapping the Menu button displays a pop-up link that takes the user to more buttons.
	View Help Selecting View Help will open an online user manual.
	Use Metric Units Selecting Metric Units will switch from English/Standard Units to Metric Units.
	Use English/Standard Units Selecting English/Standard Units will switch from Metric Units to English/Standard Units.
	Take Screen Capture Selecting Take Screen Capture will save a copy of the current open screen.

# Saved Diagnostic Data

## Overview

The Saved Diagnostic Data functions allows the capability to recall previously run tests and Data Stream Records.

ss02828

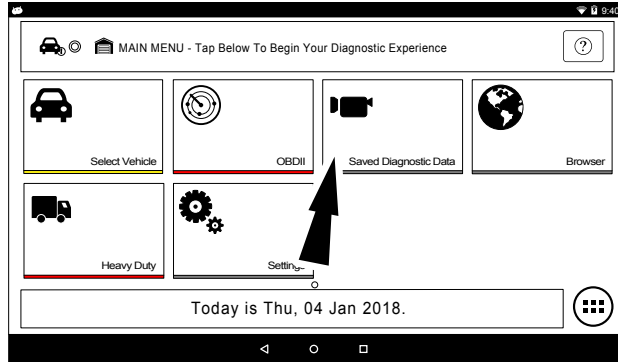

1. Select Saved Diagnostic Data from the Main Menu Screen.

ss02814

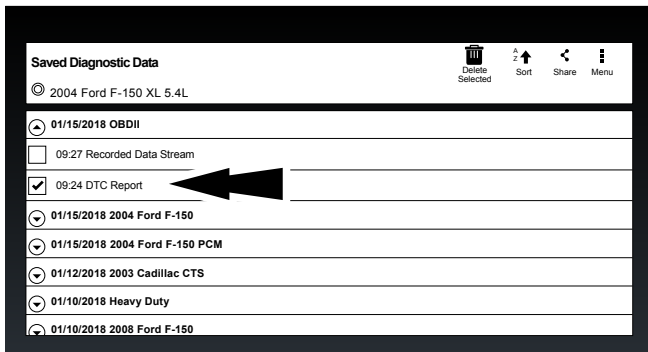

2. Navigate down to the desired saved test.  
3. Select Specific file.

ss02815

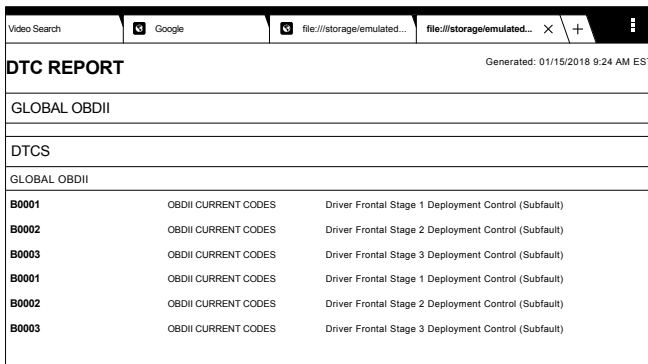

4. View the report. When finished tap the back button.

ss02816

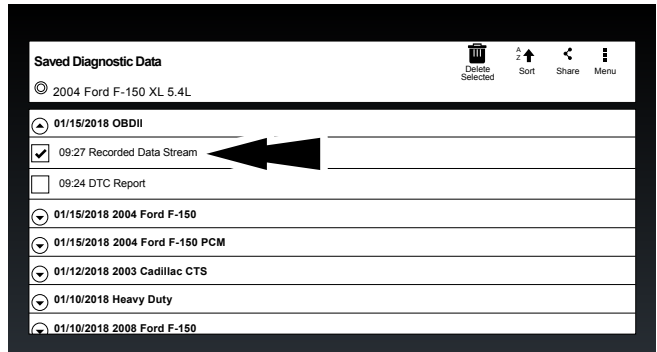

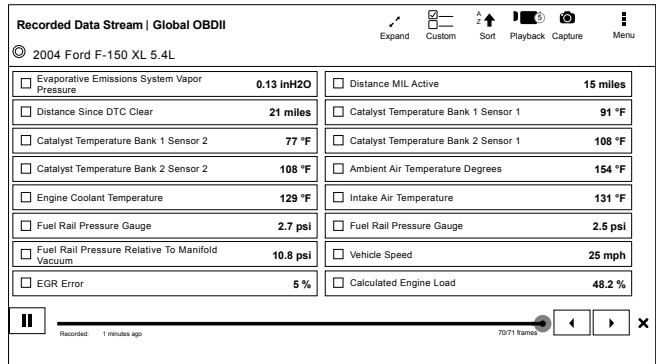

5. Navigate down to the desired saved recording.  
6. Select Specific file.

ss02817



7. View recording.

Saved Diagnostic Data Button Definitions	
	<p><b>Clear All Data</b></p> <p>Select Clear Data to clear displayed data stream. This function will reset the timeline frame counter and clear graphed data.</p>
	<p><b>Sort Function:</b></p> <ul style="list-style-type: none"> <li>Select Sort to sort data items.</li> <li>Data may be sorted alphabetically, by graph, or by selection (checkbox checked).</li> <li>Sorting data items will reset the timeline frame counter, so sort these items before recording data. If sorting data while recording the recording will have a period of time where there is no data available.</li> </ul>
	<p><b>Share DTCs Button</b></p> <p>Tapping the Share button opens the app and initiates options. Depending on what's available at the time. Share a list containing all the DTCs set by email or Bluetooth or USB.</p>

Saved Diagnostic Data Button Definitions	
	<p><b>Menu Button</b></p> <p>Tapping the Menu button displays a pop-up link that takes the user to help content related to reading DTCs.</p> <p>Note: an active internet connection will be required.</p>
	<p><b>View Help</b></p> <p>Selecting View Help will open an online user manual.</p>
	<p><b>Take Screen Capture</b></p> <p>Selecting Take Screen Capture will save a copy of the current open screen.</p>

## Browser

### Overview

An internet browser window is available for direct internet access.

ss02829

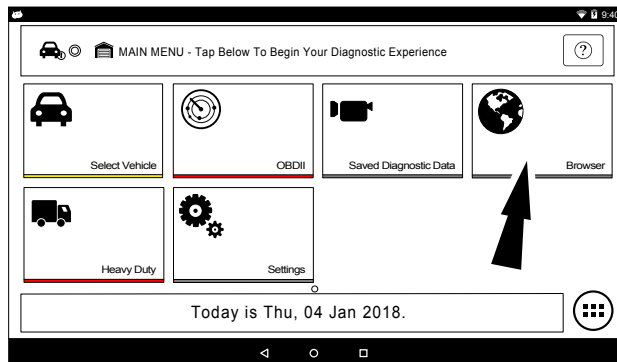

1. Select Browser from the Main Menu Screen. The Handset will launch the internet browser. Links to common technical and repair websites are provided. Select the keyboard icon to input text.

Note: The handset will need to have a Wi-Fi connection.

## CONNECTING TO WI-FI NETWORKS

See Android Settings for more information on setting up and connecting to a wireless network.

ss02732

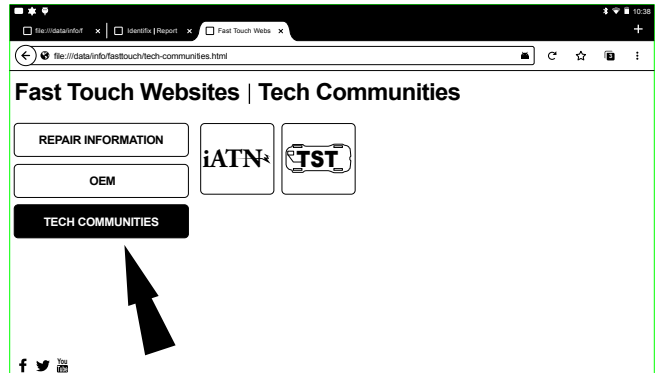

2. Select Tech Communities brings up appropriate tech community web page.

ss02733

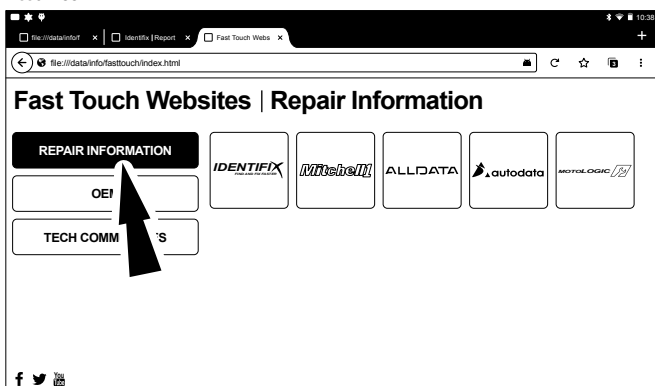

3. Select Repair Information brings up appropriate repair information web page.

ss02734

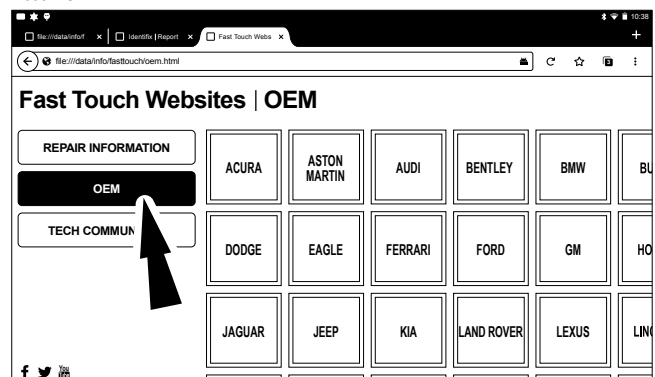

4. Select OEM brings up the manufactures technical web page.

## Heavy Duty

ss02830

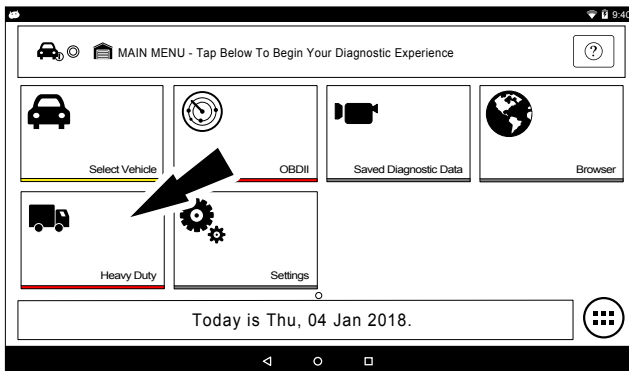

### 1. Select Heavy Duty.

*Note: You need to have a Heavy Duty subscription in order for Heavy Duty to be selectable.*

ss02371

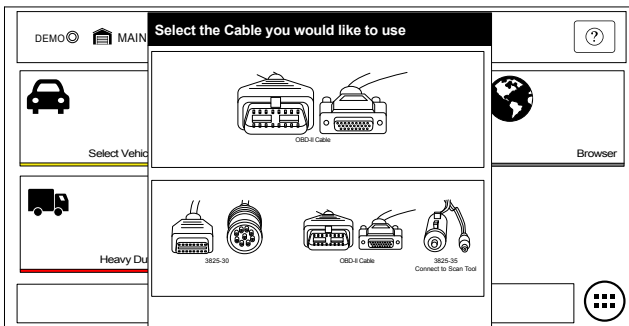

### 2. Select a Cable.

ss02838

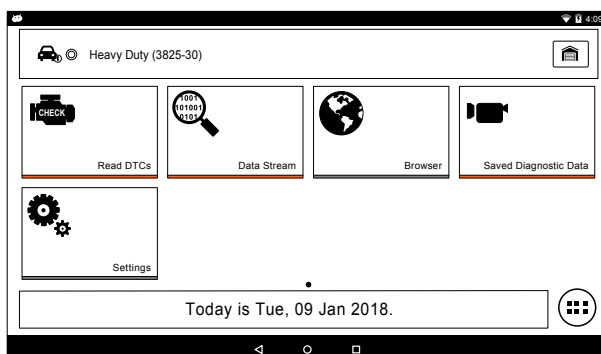

### 3. At this point vehicle entry will disappear and the user will be able to begin using diagnostic functions on the vehicle.

*Note: Special Test, Diagnostic Information, Maintenance Tests, All System DTC Scan, Automated System Test are not available.*

## J1587/1708 DTC Nomenclature

### MID - Message Identification

The MID Identifies the Component

Example: MID 128 = Engine

MID 130 = Transmission

MID 136 = Brakes (ABS)

### PID - Parameter Identification

The PID Identifies the data from a components electrical parts

Example: PID 084 = Road Speed (MPH)

PID 100 = Engine Oil Pressure (PSI)

PID 177 = Transmission Oil Temperature (Degrees)

### SID - Subsystem or Status Identification

The SID identifies the status of a components electrical part.

Example: SID 001 = Injector Cylinder #1 (On/Off)

SID 034 = Reverse Switch (Open/Closed)

SID 163 = Transmission Range (HI/LO)

*Note: MID related SID's start with Number 1 and sequentially increase. Common SID's start at Number 255 and sequentially increase.*

### FMI - Failure Mode Identifier

The FMI describes the type of failure detected in the part identified by the PID or SID. The FMI, and either the PID or SID combined to form a given diagnostic Fault code.

Example: FMI 002 = Data erratic, Intermittent or incorrect

FMI 005 = Current below normal or Open circuit

FMI 007 = Mechanical System Not Responding

FMI 011 = Failure Mode not Identifiable

### Normal Message

MID-PID/SID-FMI or

128-084-002

128 = Engine

084 = Vehicle Speed Sensor

002 = Data erratic, Intermittent or incorrect

Example: The Vehicle speed sensor circuit is bad.

## J1939 DTC Nomenclature

### SA - Source Address

The SA field contains the ECU that is sending the message

Example: SA 0 = Engine

SA 3 = Transmission

SA 11 = Brakes System Controller

### SPN - Suspect Parameter Number

The SPN is used to identify the item for which diagnostics are being reported.

Example: SPN 156 = Injector Timing Rail 1 Pressure

SPN 031 = Transmission Range Position

SPN 639 = J1939 Network

### FMI - Failure Mode Identifier

The FMI describes the type of failure detected in the part identified by the SPN. The FMI, and either the SPN combined to form a given diagnostic Fault code.

Example: FMI 002 = Data erratic, Intermittent or incorrect

FMI 005 = Current below normal or Open circuit

FMI 007 = Mechanical System Not Responding

FMI 011 = Failure Mode not Identifiable

### Normal Message

SA/SPN/FMI or

3-639-02

03 = Transmission

639 = J1939

002 = Data erratic, Intermittent or incorrect

Example: The Transmission has detected the J1939 network has an error.

## Read DTCs All Systems

### Overview

The Read DTCs All Systems will scan all available controllers on the selected vehicle.

Depending on the vehicle, the handset may ask qualifying questions concerning particular controller types for the vehicle being scanned. If unsure what selection to pick find the manufacturer's Regular Production Option (RPO) Code list sticker on the vehicle, then find the corresponding code for the desired controller. Typical locations for the RPO are the trunk, glove box, or doorjamb area.

These questions may be skipped by selecting Skip Controller. Scan progress will be indicated by the progress bar near the top of the screen.

ss02845

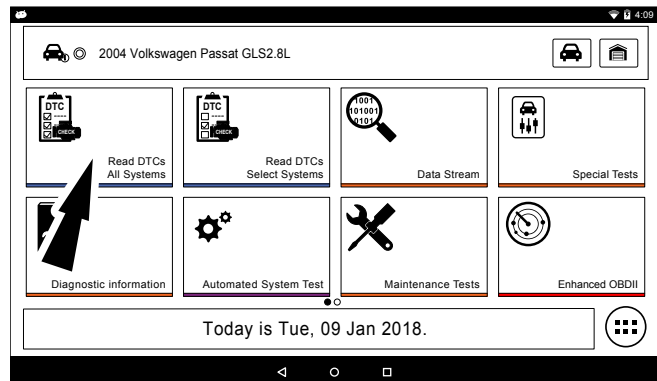

1. Select Read DTCs All Systems from the Screen.

ss02739

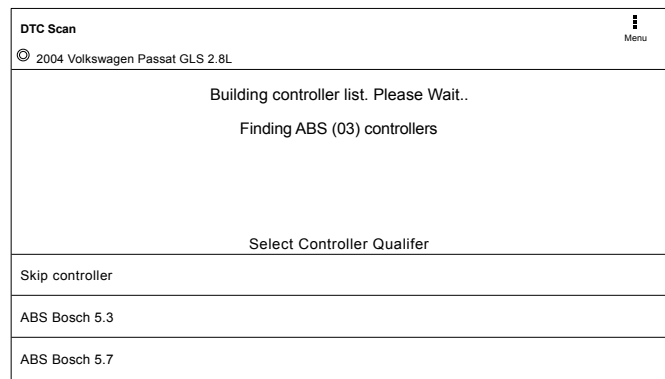

2. Select all controller qualifiers.

*Note: Not all vehicles will have qualifiers.*

ss02740

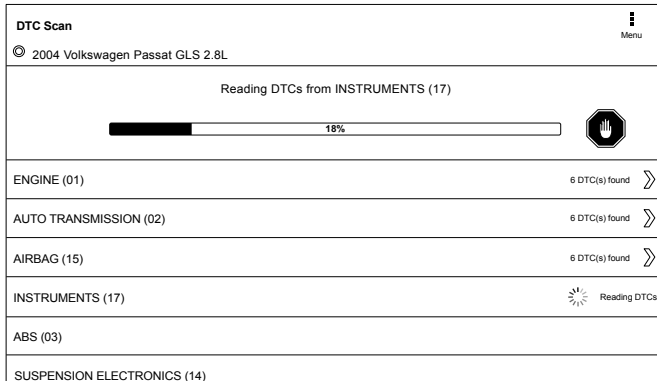

**3. Scan progress will be indicated by the progress bar in the middle of the screen.**

*Note: If any of the controllers have DTC's go to step 6.*

ss02741

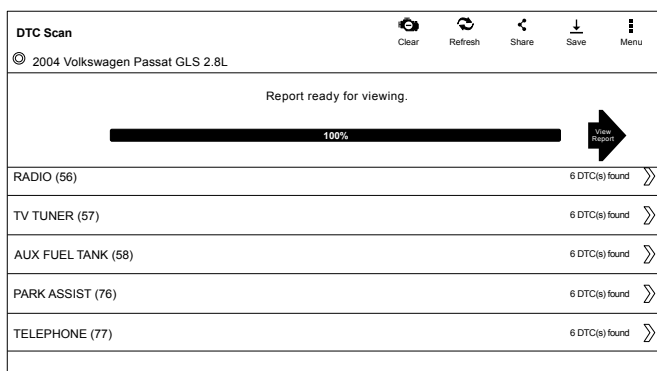

**4. Wait for scan to finish.**

ss02742

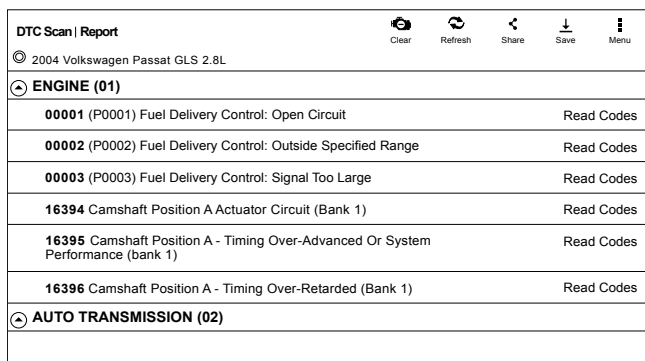

*Note: There is no arrow beside controller without a DTC and clicking on that line does nothing.*

**5. The controller without a DTC has no DTC line that is selectable and clicking on the line has no effect.**

**6. DTCs will be read from all available vehicle controllers.**

- Select a listed DTC for Related Diagnostic Information See Diagnostic Information

**section**

- If a DTC has Code Criteria available there will be an "\*" next to the DTC. Once completed the handset will display a list of all the DTCs found on the vehicle and group them by controller. If the handset was unable to communicate with a controller, it will be indicated under the specific controller. Communication problems on certain controllers may be attributed to the vehicle not having that controller. Controllers are sometimes listed for a particular vehicle that do not actually exist.

Read DTCs Button Definitions	
	<b>Refresh DTCs Button</b> Tapping the Refresh button initiates a fresh scan of DTCs from the vehicle.
	<b>Share DTCs Button</b> Tapping the Share button opens the app and initiates options. Depending on what's available at the time. Share a list containing all the DTCs set by email or Bluetooth or USB.
	<b>Menu Button</b> Tapping the Menu button displays a pop-up link that takes the user to help content related to reading DTCs. <i>Note: an active internet connection will be required.</i>
	<b>View Help</b> Selecting View Help will open an online user manual.
	<b>Take Screen Capture</b> Selecting Take Screen Capture will save a copy of the current open screen.

## Read DTCs Select Systems

### Overview

The Read DTCs Select Systems function allows reading, clearing, printing, and sharing (wireless or email) of vehicle DTCs. Onboard Code Assist information may also be available, for selection when DTCs are found. This information contains pertinent details regarding the selected DTC. For more detailed comprehensive information, go to Service and Settings, Direct-Hit® to subscribe.

Vehicle must be selected and the handset must now be displaying the Screen.

ss02839

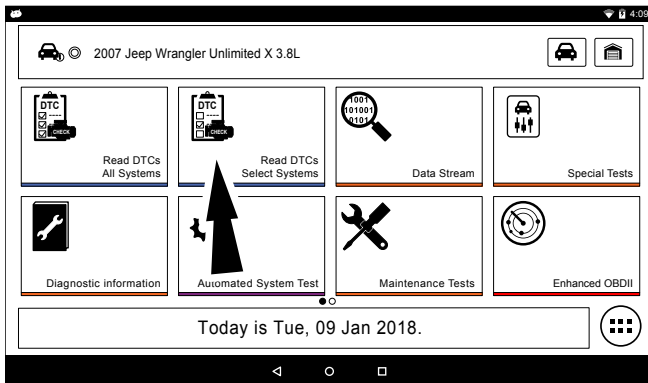

1. Select Read Select Systems from the screen.

ss02743

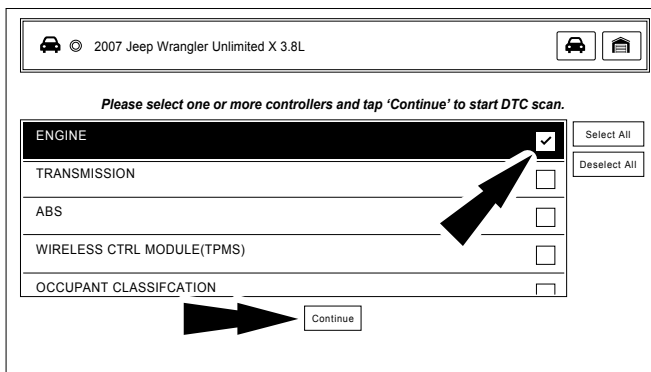

2. Select the desired vehicle controller then select continue.

ss02744

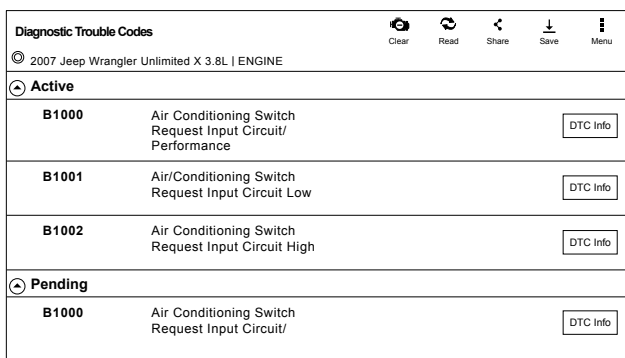

3. DTCs will be read from the selected vehicle controller.

- Select a listed DTC for Related Diagnostic Information See Diagnostic Information section.
- If a DTC has Code Criteria available there will be an "\*" next to the DTC.

### Read DTCs Button Definitions

	<p>Ford/Lincoln/Mercury Self Diagnostics button displays a pop up menu allowing the user to choose between specific special tests.</p>
	<p>GM/GMC Status button displays a pop up menu allowing the user to view the status on DTCs.</p>
	<p>Clear DTCs Button The Clear DTCs button is used to clear codes and remove all but permanent DTCs on the selected controller. To clear codes, complete the following: <i>NOTE:</i></p> <ul style="list-style-type: none"> <li>• Clearing DTCs will erase current Mode 1 Readiness monitor information and require the user go through necessary drive cycles over again. So, if Mode 1 information needs to be reviewed, be sure to view it before clearing codes.</li> <li>• If a code will not clear, turn the ignition off for at least 10 seconds; turn it back on to KOEO, then retry. Some controllers will go to sleep after a period of inactivity and prevent clearing DTCs. This key cycle may be needed when attempting to communicate with other controllers after a period of time on a different controller.</li> </ul>
	<p>Refresh DTCs Button Tapping the Refresh button initiates a fresh scan of DTCs from the vehicle.</p>
	<p>Share DTCs Button Tapping the Share button opens the app and initiates options. Depending on what's available at the time. Share a list containing all the DTCs set by email or Bluetooth or USB.</p>
	<p>Menu Button Tapping the Menu button displays a pop-up link that takes the user to help content related to reading DTCs. <i>Note:</i> an active internet connection will be required.</p>
	<p>View Help Selecting View Help will open an online user manual.</p>
	<p>Take Screen Capture Selecting Take Screen Capture will save a copy of the current open screen.</p>

## Ford/Lincoln/Mercury

When connected to a Ford/Lincoln/Mercury vehicle a pop up menu allowing the user to choose between specific special tests.

ss02840

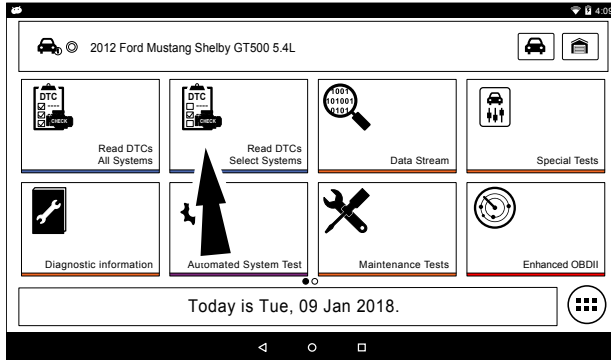

1. Select Read DTCs from the screen.

ss02745

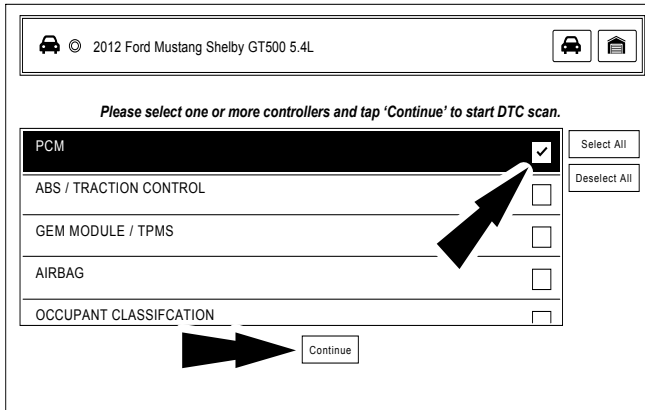

2. Select the desired vehicle controller then select continue.

ss02746

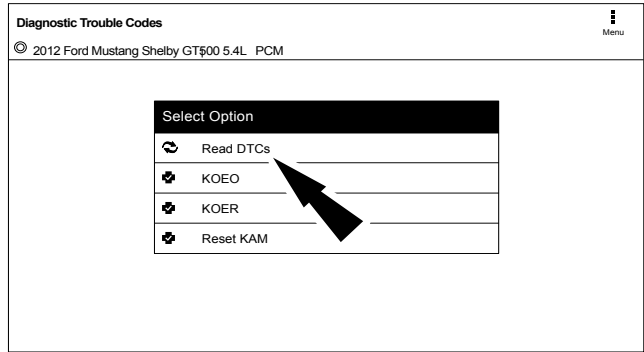

3. Tapping an option in the menu takes the user to that test. Follow the prompts on the screen.

ss02747

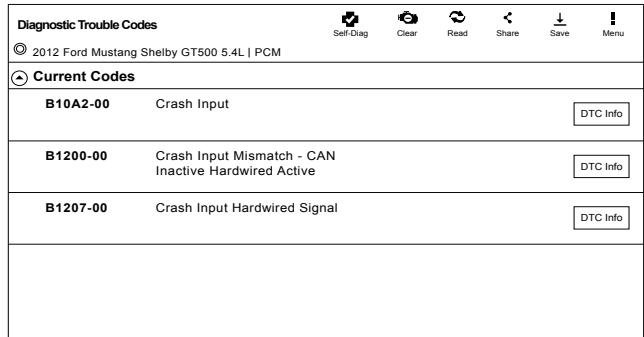

4. DTCs will be read from the selected vehicle controller.

- Select a listed DTC for Related Diagnostic Information See Diagnostic Information section
- If a DTC has Code Criteria available there will be an "\*" next to the DTC.

## Manual DTCs

Certain vehicles do not support standard DTC protocol and will require a manual process for retrieving and clearing codes.

ss02748

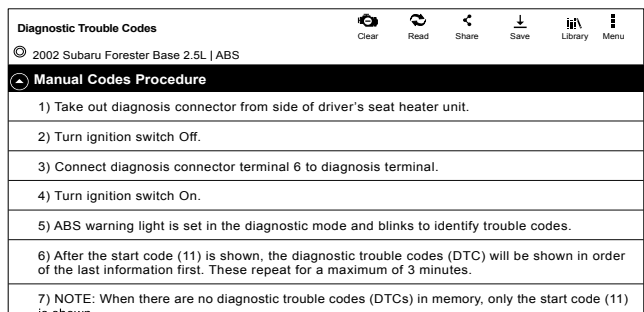

1. Follow the prompts on the screen for retrieving DTCs.



ss02749

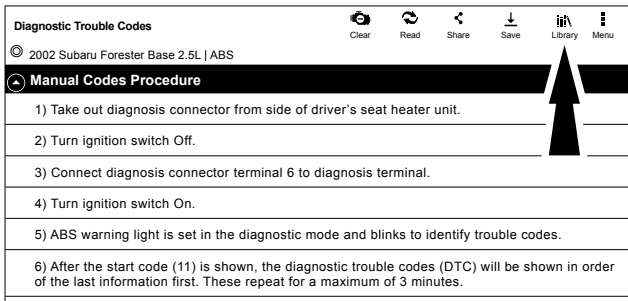

2. Select Library button.

ss02750

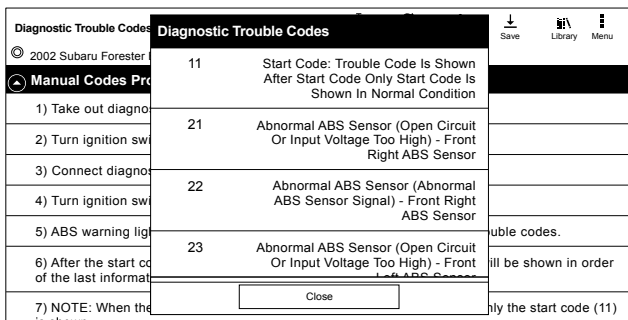

3. Follow the prompts on the screen.

ss02751

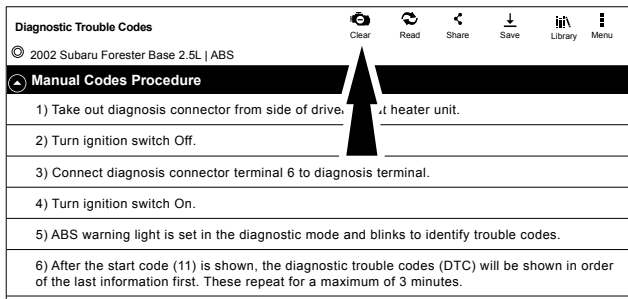

4. Select Clear DTCs button.

ss02752

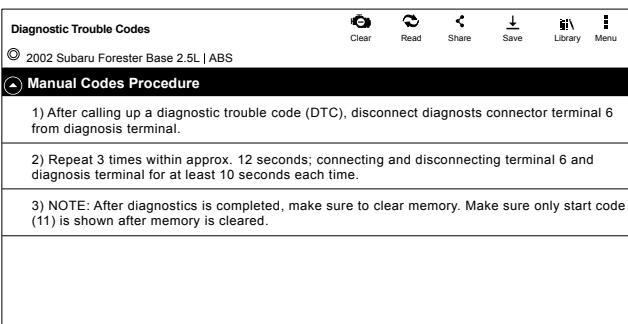

5. Follow the prompts on the screen.

## Code Criteria

Codes will be read from the selected controller and displayed on the screen.

ss02753

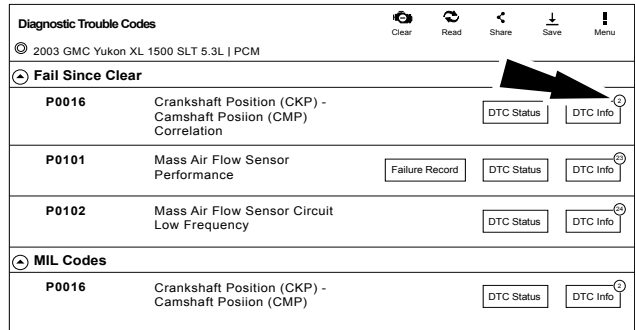

If a DTC has code criteria available there will be an indication in the upper right corner of the listed DTC.

ss02754

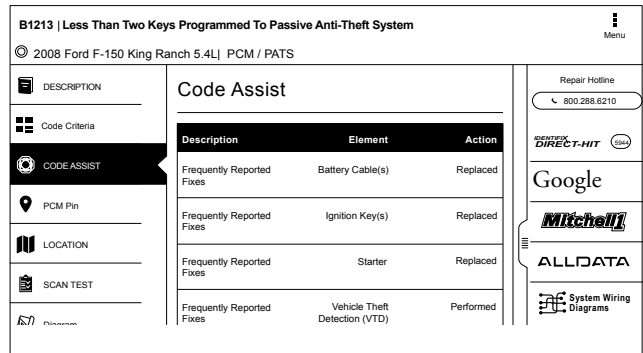

### DTC Info

DTC Info allows the technician to find details related to a given DTC.

### Description

Displays the description associated with the selected DTC.

### Code Criteria

Provides information regarding how the DTC is set.

### Code Assist

Provides information regarding the kind of action other technicians found successful when faced with the same DTC.

### PCM Pin

Provides detailed information related to the actual pins on the PCM that are associated with the selected DTC.

### Location

Aids the technician in determining where on the vehicle their attention should be directed.

### Scan Test

Provides the technician with detailed test steps.

### Diagram

Provides a circuit diagram related to the selected DTC.

### Waveform

Presents reference waveform information to help the technician understand and fix the problem.

### TSB Reference

Provides the technician with TSBs associated with the selected DTC.

### Connector

Presents information related to the connector to help the technician understand and fix the problem.

## Data Stream

The data stream function shows live sensor and solenoid data streaming from the vehicle ECU (electronic control unit). Connect the VCI with the vehicle at key on engine off or key on engine running to see live dynamic data, instead of static live data. Each data item has a selection checkbox and a display format menu.

### Basic Data Stream Procedure

ss02841

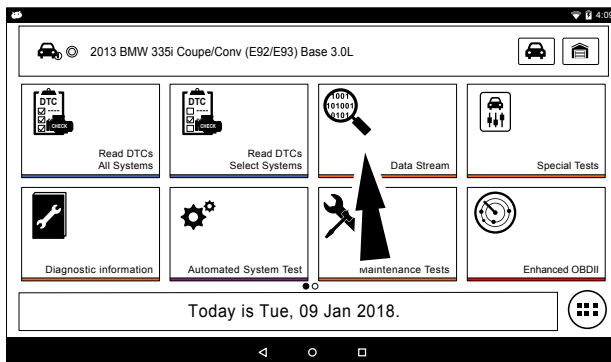

1. From the screen, select Data Stream.
2. If the vehicle is NOT a Volkswagen/Audi then go to step 7.

ss02755

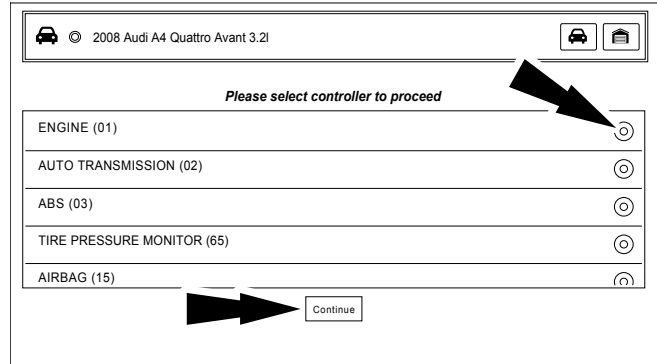

3. Select the desired vehicle controller then select continue.
4. Follow the prompts on the screen.

ss02756

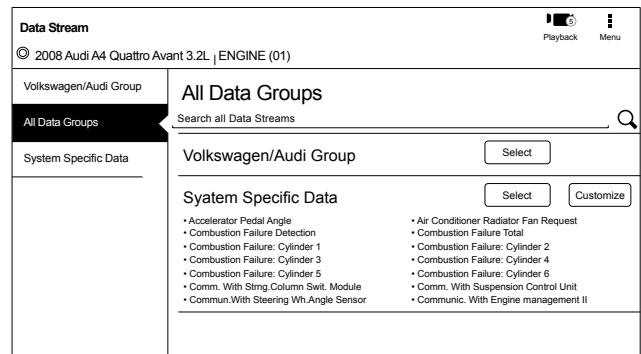

### Data Groups

- Data groups may be selected at any time within data stream.
- Select the data group menu button from the top of the screen.
- Scroll through the menu until the desired data group is found, then select it.

5. Follow the prompts on the screen. Select or customize a group.

ss02757

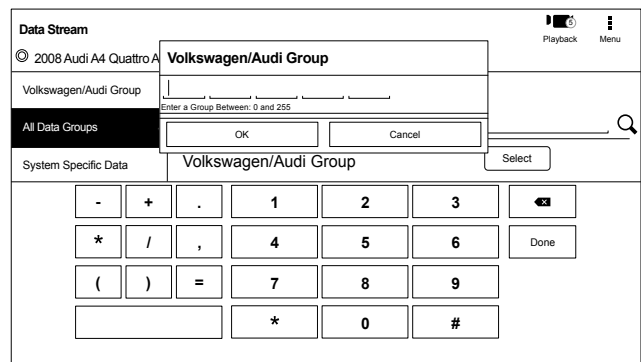

6. Enter the Volkswagen/Audi Group. When finished go to Step 10.

ss02758

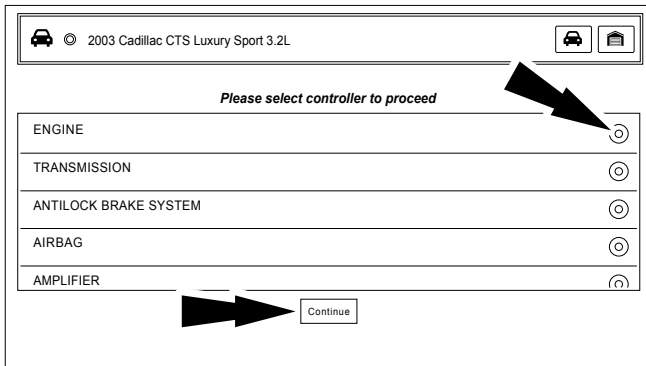

7. Select the desired vehicle controller then select continue.
8. Follow the prompts on the screen.

ss02759

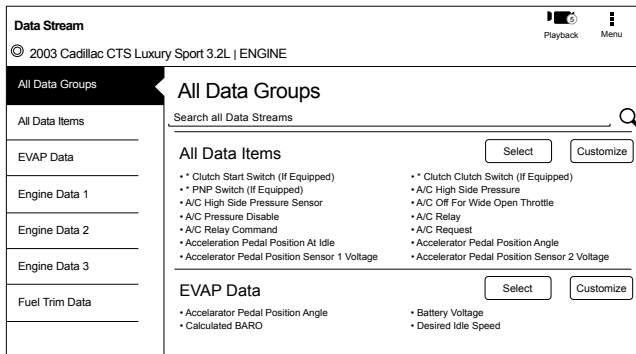

- Data Groups
- Data groups may be selected at any time within data stream.
- Select the data group menu button from the top of the screen.
- Scroll through the menu until the desired data group is found, then select it.
- Follow the prompts on the screen. Select, Select or Customize a group.

9. The selected data will be displayed.

ss02760

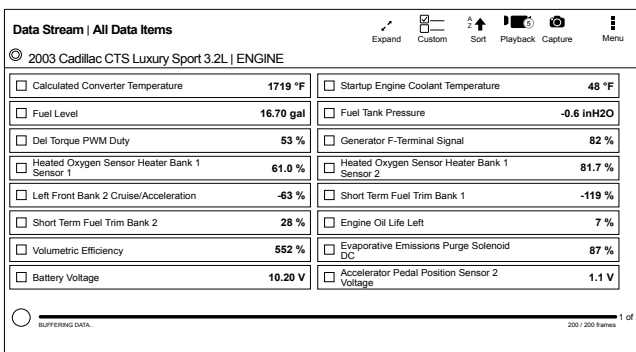

10. The selected data will be displayed.

## Enlarge Screen View Function

ss02761

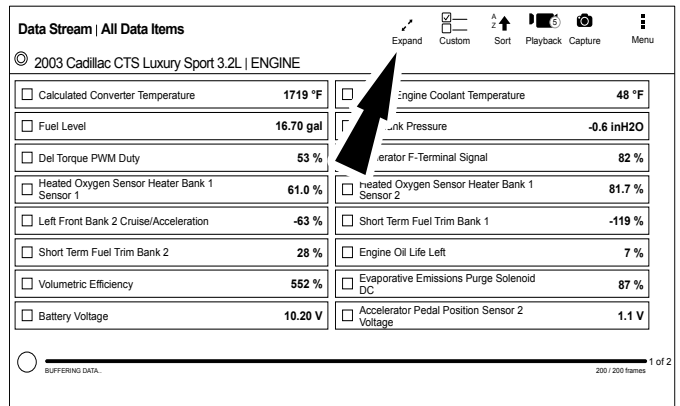

1. To view the data in the Enlarge view, press the Enlarge button.

ss02762

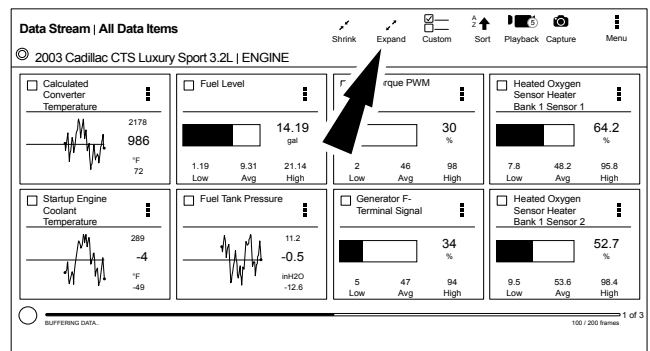

1. Press the Enlarge button again.

ss02763

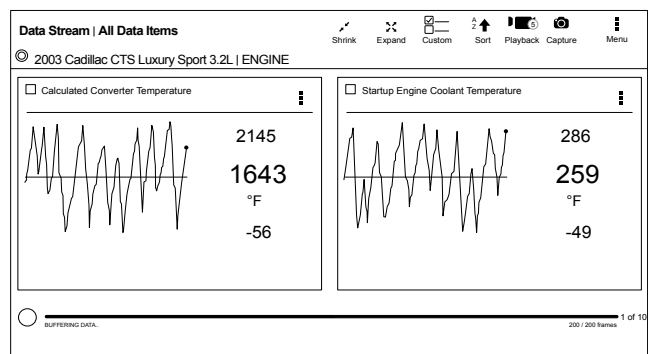

Note: The far left 2-data tiles will be enlarged to select the specific data tiles to be enlarged.

To see more graphs use your finger to swipe the screen.

Note: Depending on your Scroll Options preference either horizontally or vertically.

Data Stream View Button Definitions	
	<p><b>Reduce View Function</b> To Zoom Out, press the Reduce View button.</p>
	<p><b>Enlarge View Function</b> To view the data in the enlarge view, press the Enlarge View button.</p>
	<p><b>Zoom Out Function</b> To Zoom Out, press the Zoom Out button.</p>
	<p><b>Zoom In Function</b> To view the data in the Full Screen Mode, press the Zoom In button.</p>

### Full Screen View Function

To view the data full screen, press Full Screen button.

ss02764

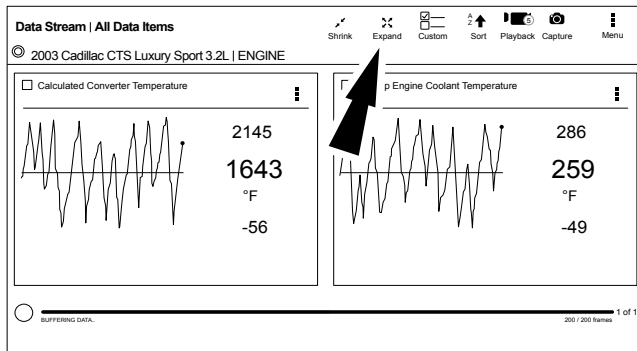

Note: The left graph will be shown full size.

ss02765

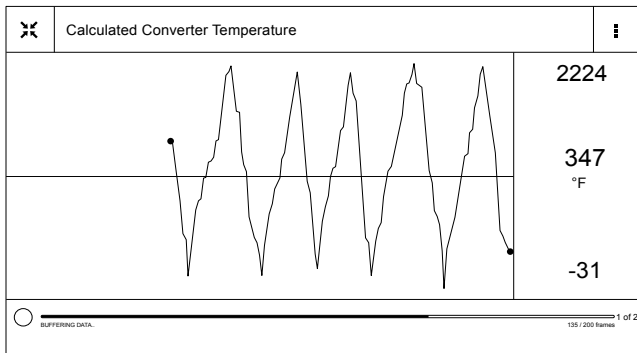

To see more graphs use your finger to swipe the screen.

Note: Depending on your Scroll Options preference either horizontally or vertically.

### Display Types

To change data item display types, select the data item menu button located in upper right.

ss02766

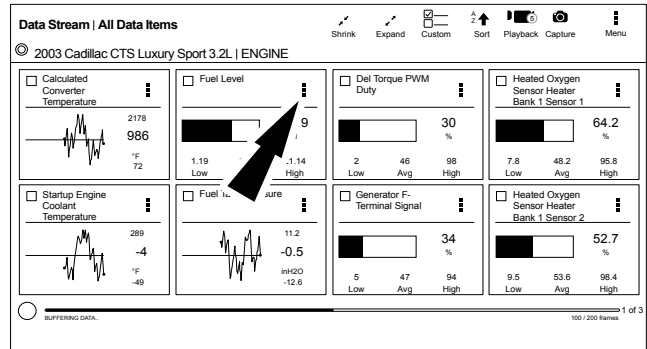

Display Type Button Definitions	
	<p><b>Menu Button</b> Tapping the Menu button displays a pop-up link that takes the user to more buttons.</p>
	<p><b>Digital</b> To change to digital form, select the ## Digital button.</p>
	<p><b>Line Graph</b> To change to line graph, select the Line Graph button.</p>
	<p><b>Bar Graph</b> To change to bar graph, select the Bar Graph button.</p>
	<p><b>Change Color</b> To change the color of a graph, select the Change Color button.</p>
	<p><b>Clear All Data</b> Select Clear Data to clear displayed data stream. This function will reset the timeline frame counter and clear graphed data.</p>
	<p><b>Take Screen Capture</b> Selecting Take Screen Capture will save a copy of the current open screen.</p>
	<p><b>Use Metric Units</b> Selecting Metric Units will switch from English/Standard Units to Metric Units.</p>

## Display Type Button Definitions

Use English/Standard Units  
 Selecting English/Standard Units will switch from Metric Units to English/Standard Units.

NOTE: Not all display types are available for all data items.

## Select Function

ss02767

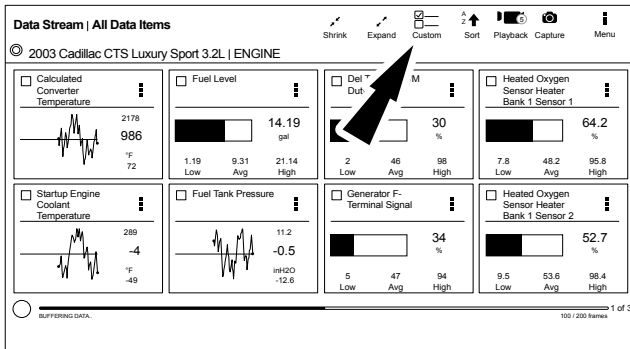

1. Select the Custom button.

ss02768

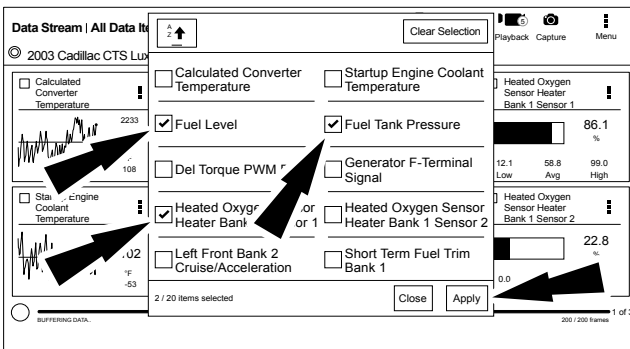

2. Choose only the data you want to view by checking the box in front of each desired data item.

3. Select apply.

## Sort Function

ss02769

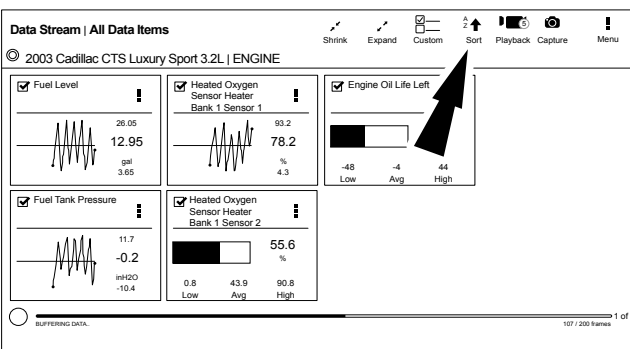

1. Select Sort to sort data items.

ss02770

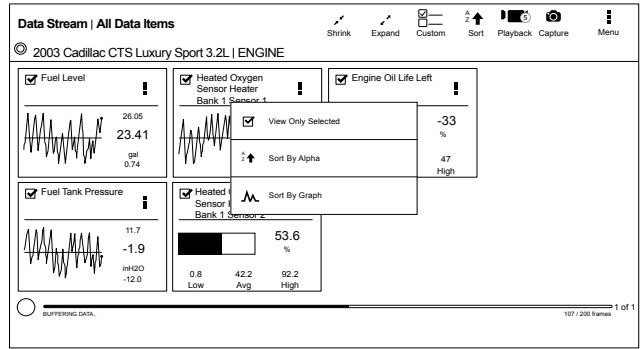

2. Data may be sorted alphabetically or by graph.

NOTE: Some of the instruction text may not exactly match what is

NOTE: Sorting data items will reset the timeline frame counter, so sort these items before recording data.

## Recording

ss02771

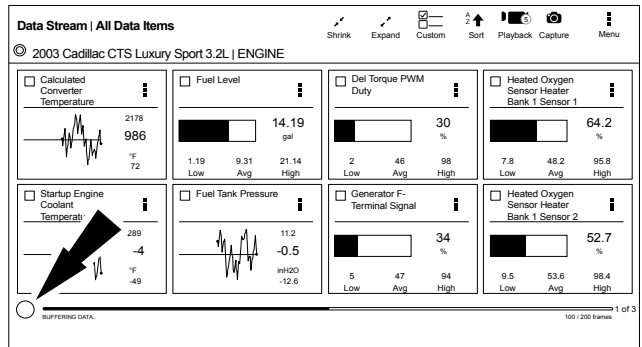

1. Select the red record button located at the bottom left of screen.

- When recording the red record button will turn into a check mark.

ss02772

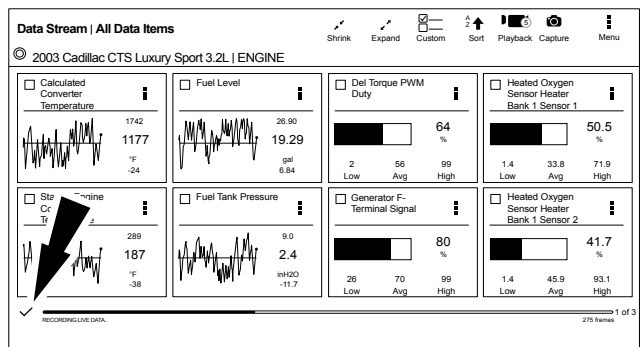

2. To stop recording select the check mark.

## Recordings

ss02773

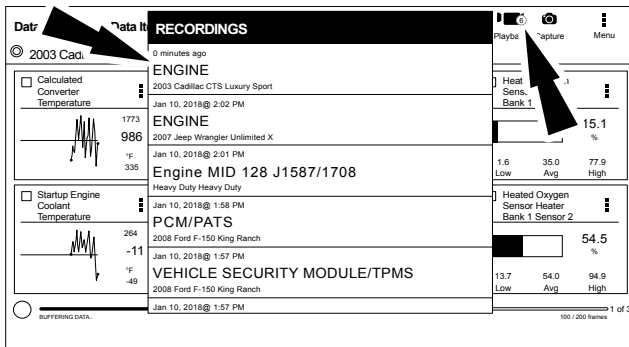

1. Select Playback to view previously recorded data streams.
  - Recordings are listed from newest to oldest. When the folder is full, the newest recording pushes the oldest one out of the list.
  - To view recordings, select the Recordings button near the top of the display.
2. Select the desired recording.

## Playback Instructions

ss02774

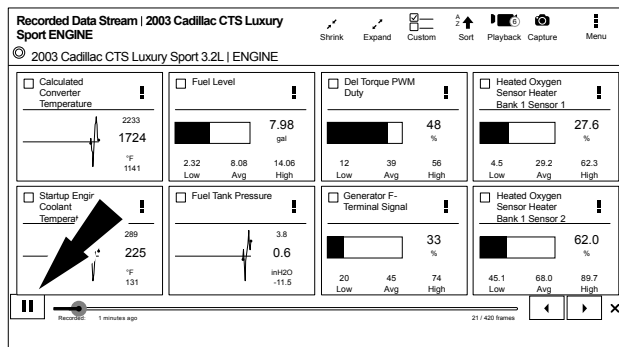

- To pause the display select Pause.
- To resume the recording, select Pause.
  - To advance the recording frame-by-frame:
    - Select ">".
    - Select either "<" or ">".
    - If replay is desired, click and drag the timeline marker back to the beginning of the timeline and release.

## Special Tests

### Overview

Depending on the vehicle and controller selected, special tests are available.

The special test function is a key component of the tool because it allows circuit testing without ever touching a circuit with a DVOM or other electrical testing equipment. This will also protect electrical circuits from being contaminated or damaged from manual testing with electrical troubleshooting equipment. It is also a quick and easy way to test vehicle controller operation which is difficult to test using traditional methods.

ss02842

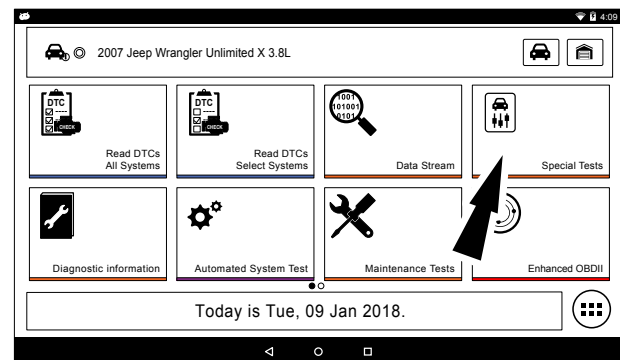

1. Select Special Tests from the screen.

ss02775

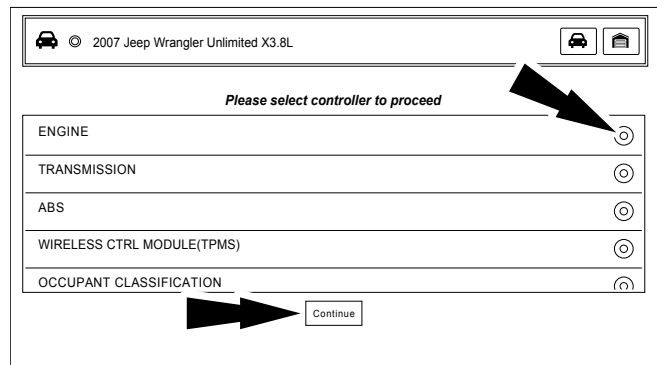

2. Select the desired vehicle controller then select continue.

ss02776

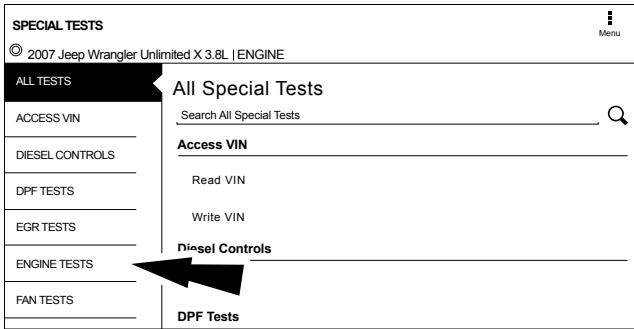

- At the special test screen, select a special test group from the group selection menu, then select the desired special test within the desired test group.

ss02777

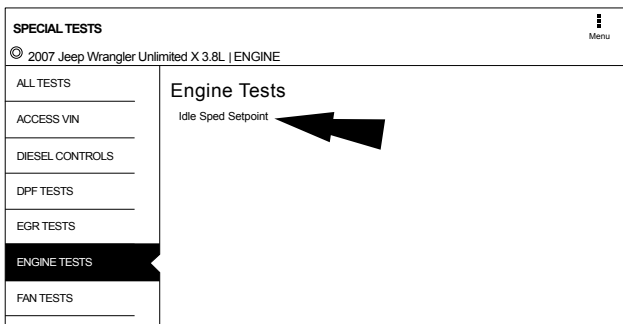

- Only the tests meeting the search criteria are displayed. Select the desired test to be executed.

*Note: Some tests may require a registration like Tire Pressure Sensor Test.*

ss02778

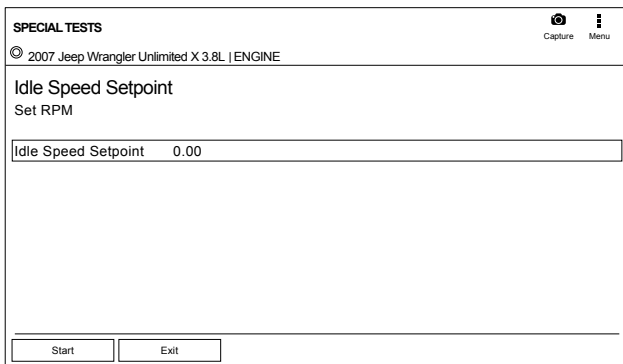

- Follow the prompts on the screen.

**NOTE:** Some of the instruction text may not exactly match what is on the screen. This will be updated as product updates are released.

ss02779

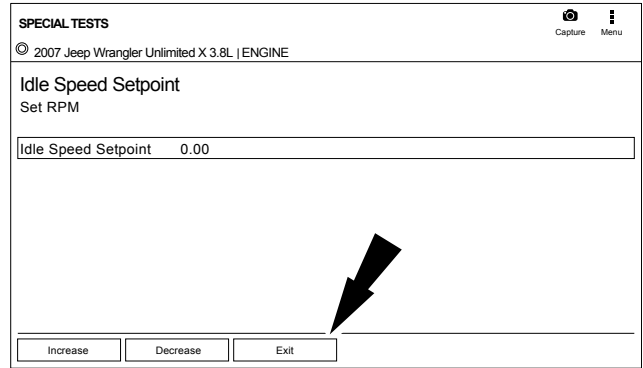

- To terminate a test at any time, use the emergency stop button. To exit special tests normally, select the exit or abort button.

*Note: Exit or abort will both stop the current special test and take you back to the start of Special Tests.*

All features outside the special test are locked out until the test is terminated to protect the vehicle and the person running the special test. If a function outside the special test is desired, terminate the test and proceed to the desired function. Special tests are not available for all vehicles and controllers. The air bag controller will rarely provide special tests, as actuating the air bag would cause damage to the steering wheel or cabin components. It would also be necessary to replace air bag modules after running the test and clean the interior. Special tests will be continuously updated as more are added; in addition, tests which do not function may be removed during updates as well. There may be tests listed that do not function on the selected vehicle. This is likely due to the fact that many vehicles have different systems depending on sub-model types.

Special Tests Button Definitions	
	<p><b>Menu Button</b></p> <p>Tapping the Menu button displays a pop-up link that takes the user to help content related to reading DTCs.</p> <p><i>Note: an active internet connection will be required.</i></p>
	<p><b>View Help</b></p> <p>Selecting View Help will open an online user manual.</p>
	<p><b>Take Screen Capture</b></p> <p>Selecting Take Screen Capture will save a copy of the current open screen.</p>



# Diagnostic Information

## Overview

Diagnostic Information provides diagnostic, repair, and reset information for the selected vehicle.

ss02843

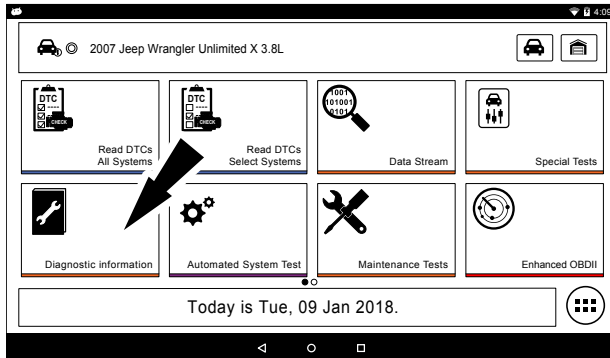

1. Select Diagnostic Information from the screen.

ss02858

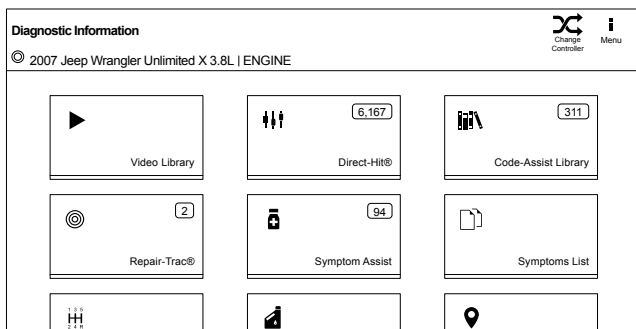

2. Select the desired function from within the Diagnostic Information menu.

## AutoDetect Results Number Indication

Diagnostic Information provides diagnostic, repair, and reset information for the selected vehicle.

- Each vehicle and controller will have its own set of indications.
- The indication is displayed on top of the Diagnostic Information selection.
- When entering diagnostic information, the application will conduct a search in the background for the selected vehicle/controller combination to determine the number of items it will contain.

*NOTE: If diagnostic information is desired for a different controller or vehicle, return to the Screen and change the controller or vehicle there, then re-select Diagnostic Information. Failure to follow this could lead to display errors or communication errors.*

*NOTE: Not all assets within the Diagnostic Information menu will utilize the AutoDetect Results Number indication feature.*

## Code Assist™ Library

This function will allow a search for DTCs by letter/number designation.

ss02792

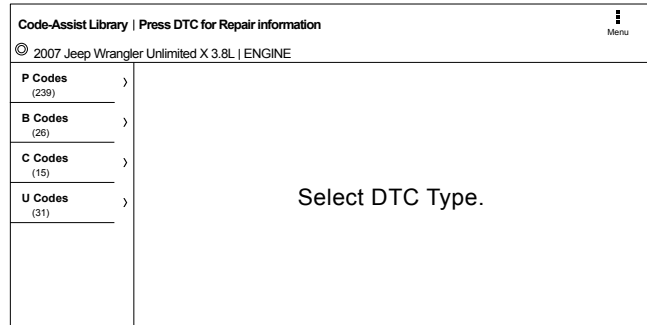

1. Select Code-Assist library from the Diagnostic Information screen.

ss02793

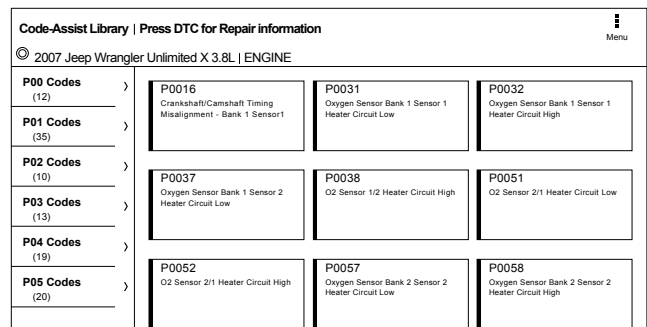

2. The next selection divides the information into subcategories B, C, P and U codes. The next selection divides previous groups even more.
3. Remaining selections will eventually filter the list down to a shortened DTC list where the user is able to scroll and select the desired DTC.
4. Select the DTC to display the DTC information.
5. To return to previous menu screens, select the back arrows at the top of the screen.

## Repair Trac®

This function uses the AutoDetect Result Number Indication feature described on the previous page.

1. Select Repair Trac® from the Diagnostic Information screen to view previously reported repairs for the selected vehicle/controller combination.



ss02794

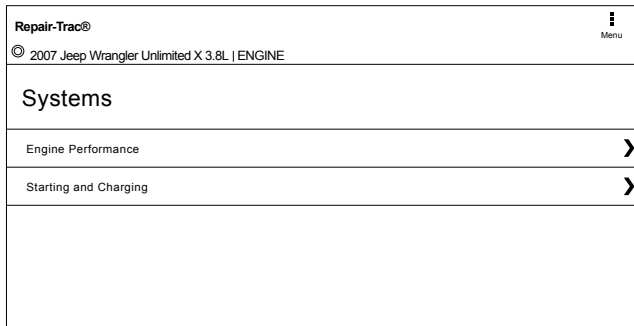

Select the desired system.

- Select the category.
- Select the deficiency.
- Select the symptom.
- Report is displayed describing the problem, how to test and fix, and related DTCs.

### Symptom Assist™

This function assists in diagnosing a problem with a vehicle component by selecting apparent symptoms.

1. Select Symptom Assist from the Diagnostic Information screen.

ss02795

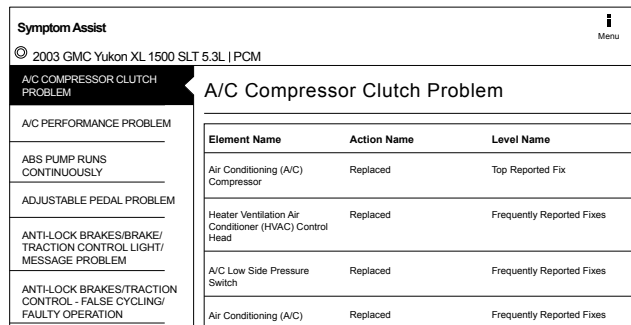

2. Select the desired component or component group.
3. Select the desired symptom within the component or component group.
4. To go back to previous screens use the back arrows near the top of the screen.

### Symptom List

Diagnostic Information provides diagnostic, repair, and reset information for the selected vehicle.

1. Select Symptom List from the Diagnostic Information screen.
  - Select Symptoms List from the Diagnostic Information menu.

ss02796

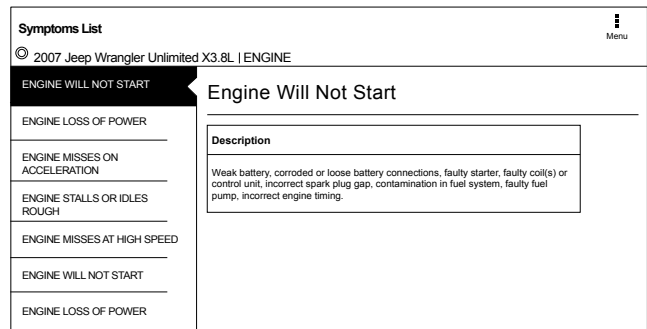

2. Select the symptom that is currently being exhibited by the vehicle on the vehicle.

### Video Library

When Video Library is selected the user will be taken to a list of videos. These videos will illustrate how to perform various functions on the handset.

1. Select Video Library from the Diagnostic Information screen.

ss02797

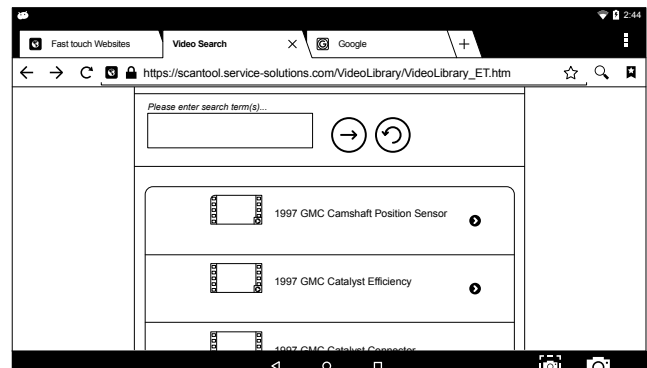

2. Search website for videos.

### Drive Cycle

The OBDII system has a series of systems that run self-tests. These systems or components have to be made ready either by simply turning on the ignition or by manipulating the system in some manner. This is called Drive Cycle. Drive cycle information is listed for continuous and non-continuous monitors.

1. Select Drive Cycle from the Diagnostic Information screen.

ss02798

Drive Cycle	
© 2003 GMC Yukon XL 1500 SLT 5.3L   PCM	
A/C SYSTEM REFRIGERANT MONITOR	1) Cold start engine coolant temperature < 50 degrees Celsius, with air conditioning & rear defrost on, idle 2.5 minutes in drive. Before proceeding turn accessories off.
CATALYST MONITOR	
COMPREHENSIVE COMPONENT MONITOR	2) Acceleration to 55 miles per hour, 1/2 throttle, air conditioning off.
EGR SYSTEM MONITOR	3) 3 minutes steady state cruise 55 & 60 miles per hour.
EVAP SYSTEM MONITOR	4) Deceleration to 20 miles per hour (clutch out) no brake.
FUEL SYSTEM MONITOR	5) Acceleration at 3/4 throttle to 55-60 miles per hour, then steady state cruise for 5 minutes.
FULL DRIVE CYCLE	6) Deceleration no brake, end of cycle.

2. Scroll through the list until the desired monitor or drive cycle is found.
3. Select the desired drive cycle and follow the instructions.

### Oil Light Reset

On newer vehicles, the oil light reset procedure will indicate how the oil life information can be reset after an oil change.

1. Select Oil Light Reset from the Diagnostic Information screen.

ss02799

Oil Light Reset	
© 2003 GMC Yukon XL 1500 SLT 5.3L   PCM	
Oil Light Reset Procedures	
	1) Turn the ignition key to the RUN position.
	2) Fully push and release the accelerator pedal 3 times within 5 seconds.
	3) if the CHANGE OIL SOON light flashes, the system is resetting.
	4) Turn the key to OFF.
	5) Start the vehicle.
	6) The oil life will change to 100%

2. Select Oil Light Reset from the Diagnostic Information menu screen.
3. Follow the prompts on the screen to turn off the indicator lamp.

### PCM Connector Pin Information

Displays a list of which connector and pin a component or sensor is received through on the PCM.

1. Select PCM Pin Information from the Diagnostic Information screen.

ss02800

PCM Pin	
© 2003 GMC Yukon XL 1500 SLT 5.3L   PCM	
PCM Pin	
Pin Number	Description
C1-1	Ground
C1-2	12 Volt Reference
C1-3	Fuel Injector 3 Control
C1-4	Fuel Injector 2 Control
C1-7	5 Volt Reference

2. Scroll through the list and select the desired sensor or component is listed.

ss02801

PCM Pin	
© 2003 GMC Yukon XL 1500 SLT 5.3L   PCM	
PCM Pin	
Connector:	C1
Connector Color:	Blue
Pin Number:	1
Wire Color:	Black/White
Description:	Ground
KOEO	N/A N/A N/A N/A

### Technical Service Bulletin (TSB) References

Displays TSBs associated with the vehicle/controller combination.

1. Select TSB Reference from the Diagnostic Information screen.

ss02802

TSB Reference	
© 2003 GMC Yukon XL 1500 SLT 5.3L   PCM	
TSB Number	TSB Description
02-09-41-001	Computers & Controls - DTC's Set When Replacing Modules
01-07-30-002C	Electrical - Malfunction Indicator Lamp ON / Automatic Transmission Stuck in 3rd Gear
01-07-30-036C	Automatic Transmission - Diagnostic Trouble Code P0756 Diagnostic Tips
01-07-30-038B	Automatic Transmission - 4L60-E / 4L65-E Malfunction Indicator Lamp ON / Diagnostic Trouble Code P0757 / Slipping
02-06-05-004A	Emissions - Catalytic Converter Damage / Misfire Codes Set

1. Scroll through the list until the desired TSB is found.

## Trans Pan ID

Displays a list of gasket images that correspond to specific transmissions.

1. Select Trans Pan ID from the Diagnostic Information screen.

ss02803

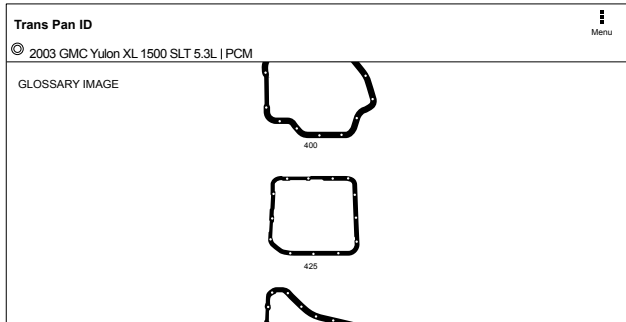

2. Scroll through the list of gasket images until the matching gasket is found. Corresponding information is listed below each image.

## Location

Used to find where specific components are located.

1. Select Location Info from the Diagnostic Information screen.

ss02804

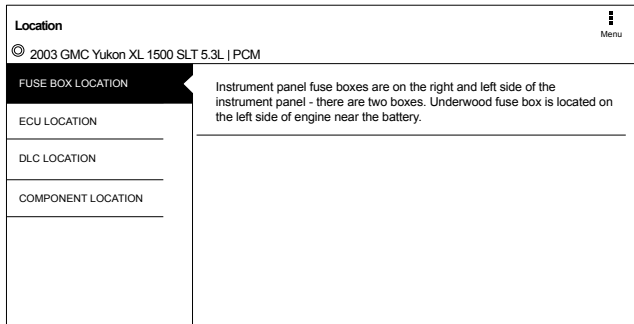

2. Scroll through the list and select the desired component.

## Brake Bleed Procedure (ABS)

Provides the procedure on how to bleed the brakes after replacing brake calipers or opening a brake line to atmosphere.

1. Select Brake Bleed Procedure from the Diagnostic Information screen.

ss02805

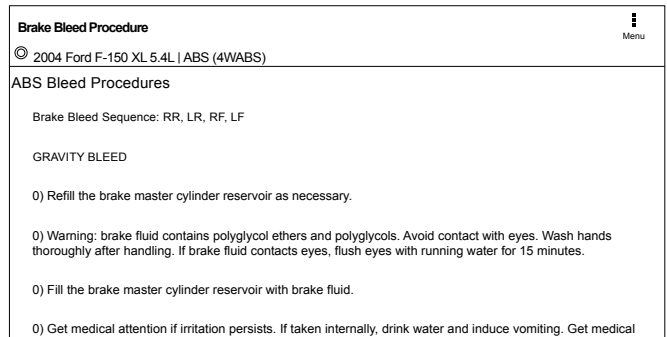

2. It may be necessary to change controllers at the Screen, then re-enter diagnostic information for this selection to become available (ABS, ABS/VSES).

*NOTE: The sequence may be contained within the previous brake bleed procedure section if it is not separately listed on the Diagnostic Information screen.*

## Tune Up Specifications

Provides specifications for specific components when a tune up is performed.

1. Select Tune Up Specs from the Diagnostic Information screen.

ss02806

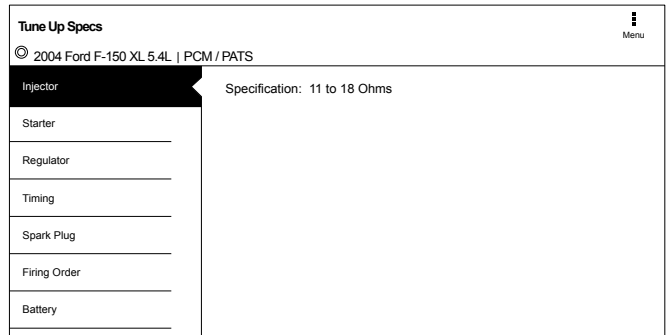

2. Some of the tune up specifications contained in this section include the following:

- Starter
- Generator
- Regulator
- Spark plug
- Idle speed
- Fuel pressure
- Compression
- Firing order

## Key Programming

Displays instructions for the selected vehicle for programming a key.

1. Select Key Programming from the Diagnostic Information screen.

ss02807

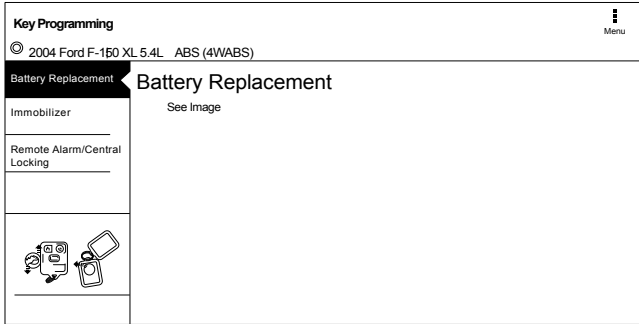

2. Follow the prompts on the screen to program a key and or replace battery in key.

## Battery Disconnect

Displays procedures for disconnect the battery on the selected vehicle.

1. Select Battery Disconnect from the Diagnostic Information screen.

ss02808

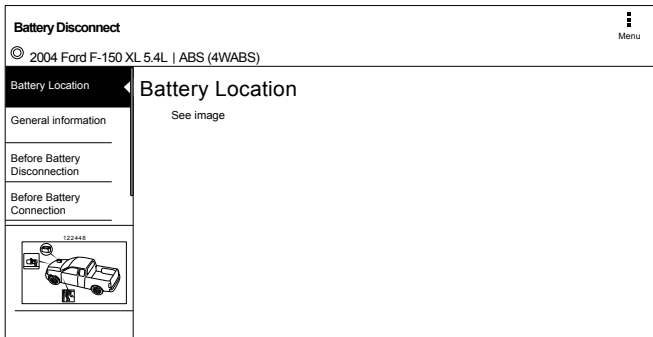

2. Follow the prompts on the screen to disconnect and connect the battery.
3. Follow procedures for updating vehicle systems after battery has been disconnected.

## TPMS Quick Info

Describes the operating procedures for the Tire Pressure Monitor System (TPMS) for the selected

vehicle.

1. Select TPMS Quick Info from the Diagnostic Information screen.

ss02809

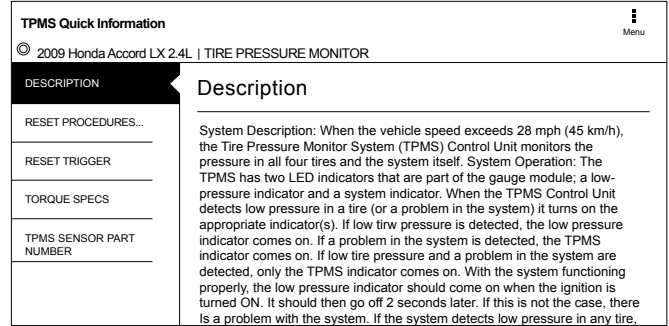

2. Follow the prompts on the screen to reset the tire pressure monitors.

Diagnostic Information Button Definitions	
	<p><b>Change Controller Button</b> Tapping the Change Controller button displays the select controller screen.</p>
	<p><b>Menu Button</b> Tapping the Menu button displays a pop-up link that takes the user to help content related to reading DTCs. Note: an active internet connection will be required.</p>
	<p><b>View Help</b> Selecting View Help will open an online user manual.</p>
	<p><b>Take Screen Capture</b> Selecting Take Screen Capture will save a copy of the current open screen.</p>

## Automated System Test

### Overview

The Automated System Test (AST) will scan all available controllers on the selected vehicle for Modes 1-7.

Depending on the vehicle, the handset may ask qualifying questions concerning particular controller

types for the vehicle being scanned. If unsure what selection to pick, find the manufacturer's Regular Production Option (RPO) code list sticker on the vehicle, and then find the corresponding code for the desired controller. Typical locations for RPO are trunk, glove box, or doorjamb. These questions may be skipped by selecting Skip Controller.

ss02846

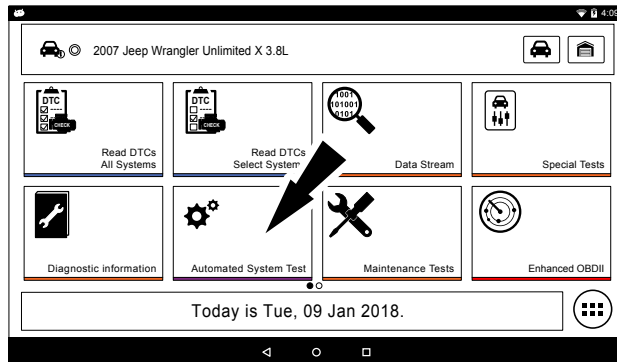

1. Select Automated System Test from the Screen.

ss02780

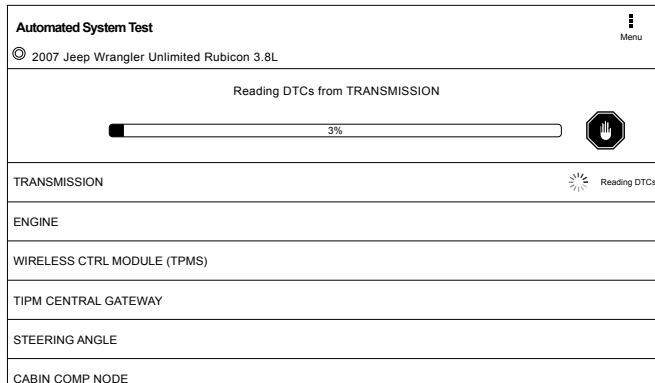

2. Wait for the list to be completed.

ss02781

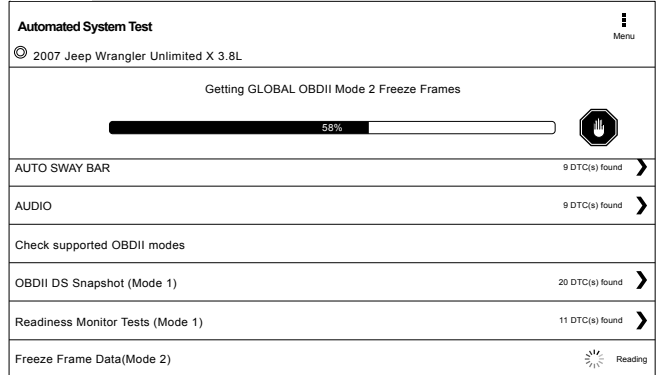

3. Scan progress will be indicated by the progress percentage bar on the screen.

ss02782

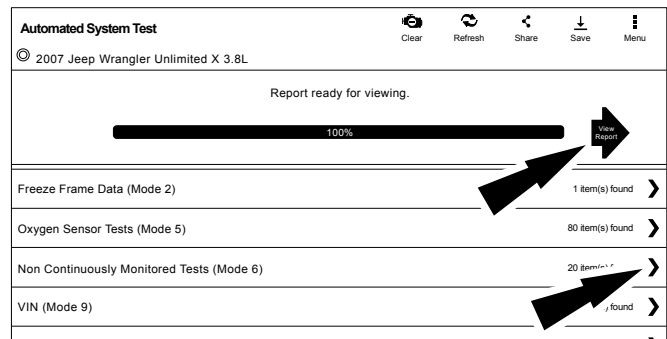

4. Select Green Arrow to review summary report.

5. If available select arrow at end of line to view information on item.

ss02783

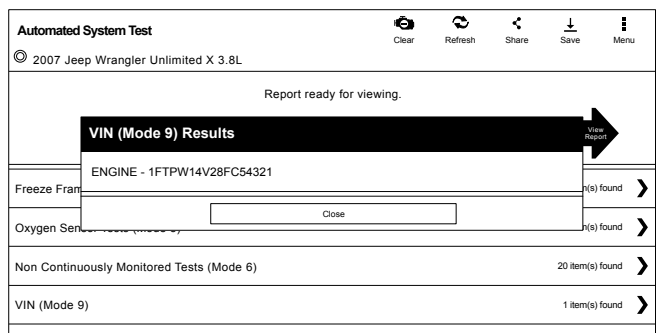

6. Follow the prompts on the screen.

NOTE: Available items will vary from vehicle to vehicle.

## Summary Report

ss02784

AST summary reports items found on the vehicle, such as:

- Controllers found on vehicle.
- DTCs.
- Data Stream Snap Shot.
- Mode 1 (Readiness Monitor).
- Freeze frame.
- Mode 5 (O2 sensor).
- Mode 6 (Non-continuous monitor tests).

NOTE: Available selections will vary from vehicle to vehicle.

## DTCs

ss02785

DTCs recorded are displayed. When selecting DTCs, diagnostic information is also available (same information as the Read DTCs screen).

## Data Stream Snapshot

ss02786

Data stream Snapshot, is a current view of the onboard vehicle sensors.

## Mode 1 (Readiness Monitor)

ss02787

Readiness Monitor Tests displays the results from the continuous monitors available on the selected vehicle. There are three states: ready, not ready, and not supported. If the monitor is not ready, a drive cycle must be completed prior to running this test. For more information regarding drive cycles, refer to diagnostic functions Mode 1 readiness.

## Freeze Frame

ss02788

1. Select a frame.

ss02789

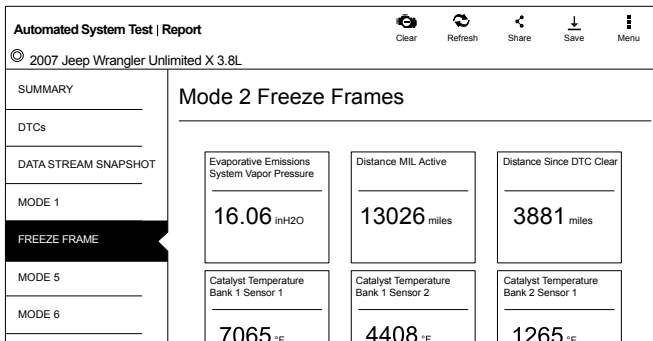

Mode 2 displays recorded data in the form of a DS snapshot by the vehicle's computer when specific DTC are set and the MIL is illuminated.

### Mode 5 (Oxygen sensor tests)

Mode 5 views O2 sensor monitor test results.

ss02790

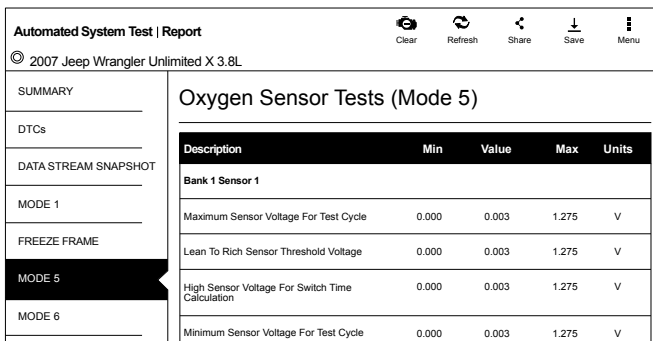

Mode 5 views O2 sensor monitor test results. Mode 5 displays the average of the O2 sensor monitor test results measured over a period of time. The parameters of this measurement vary between manufacturers. It may be necessary to run the vehicle for a period of time to allow the O2 sensors to fully warm up and begin operating.

*Note: Mode 5 is not supported on all vehicles.*

### Mode 6 (Non-continuous monitor tests)

Mode 6 views onboard monitoring test results for noncontinuous monitor systems.

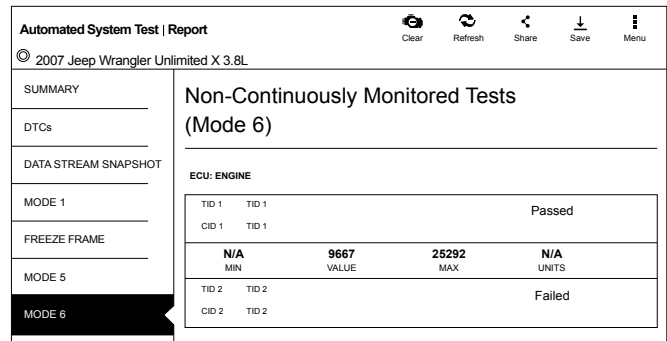

ss02791





Non-Continuous Monitor Tests (Mode 6) are pass/fail tests, including certain EVAP tests, catalyst, and EGR. The following information is reported:

- ECU.
- TID (test identification) indicates the system monitor.
- CID (component identification) indicates the component tested and its test value.
- Minimum value, maximum value, and current value for each non-continuous monitor.
- Pass or fail test result.

Each vehicle manufacturer assigns a code number to their system monitors and components. Refer to the vehicle manufacturers Mode 6 code chart to determine the failure indicated by the TID and CID. If this chart is not readily available, run an automated system test (AST) from the DTC screen and select Mode 6. See Read DTCs section for more information regarding steps to complete this action. This may provide a more detailed description of the Mode 6 test information.

Automated System Test (AST) Button Definitions	
	Refresh DTCs Button Tapping the Refresh button initiates a fresh scan of DTCs from the vehicle.
	Share DTCs Button Tapping the Share button opens the app and initiates options. Depending on what's available at the time. Share a list containing all the DTCs set by email or Bluetooth or USB.

Automated System Test (AST) Button Definitions	
	<p><b>Menu Button</b> Tapping the Menu button displays a pop-up link that takes the user to help content related to reading DTCs. <i>Note: an active internet connection will be required.</i></p>
	<p><b>View Help</b> Selecting View Help will open an online user manual.</p>
	<p><b>Take Screen Capture</b> Selecting Take Screen Capture will save a copy of the current open screen.</p>

## Maintenance Tests

### Overview

Maintenance Tests provide a way for specific systems to be recalibrated or reset after service. Maintenance test availability will vary from vehicle to vehicle, and will be updated over time.

Maintenance tests are the same as special tests, but this is a shortcut to most frequently used tests on the selected vehicle. These specific tests can also be found under special tests.

ss02844

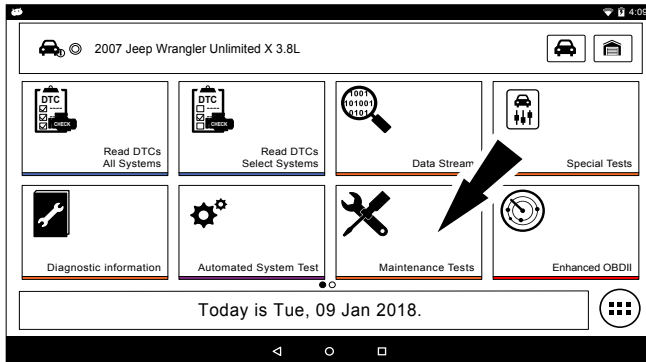

1. Select Maintenance Test from the Screen.

ss02810

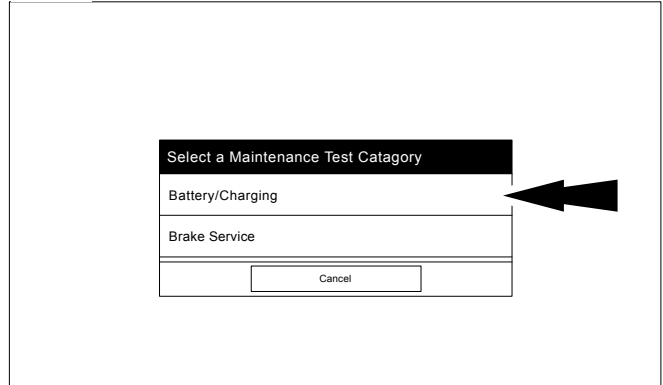

2. Select the desired category for the component or system being worked on.

*Note: If there are no sub-sections available for the selected category go to step 5.*

ss02811

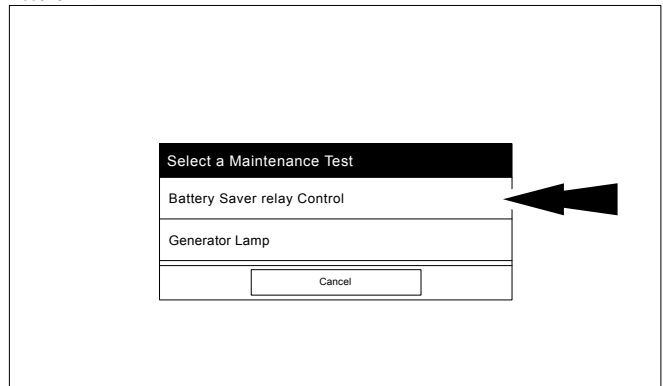

3. Select the desired test to be performed.

ss02812

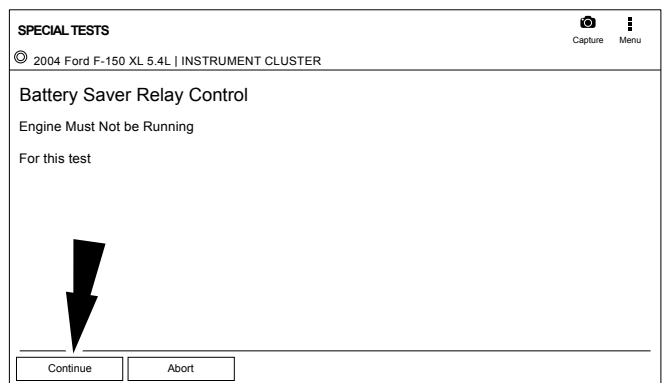



4. Follow prompts on the screen.

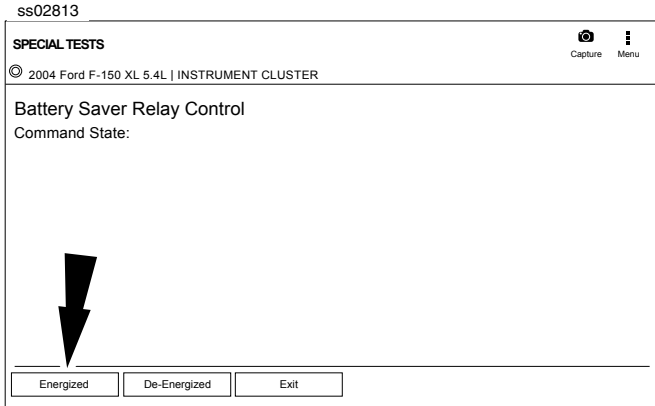



5. Run the test.

Note: For more information refer to Special Tests section.

Maintenance Tests Button Definitions	
	<p><b>Menu Button</b> Tapping the Menu button displays a pop-up link that takes the user to help content related to reading DTCs. Note: an active internet connection will be required.</p>
	<p><b>Take Screen Capture</b> Selecting Take Screen Capture will save a copy of the current open screen.</p>

## Enhanced OBDII

### Overview

Enhanced OBDII provides all of the same functions and features as Generic OBDII with the addition of OEM specific MID/TID and TID/CID descriptions for Non-Continuously Monitored Tests in Mode 6. This gives the user more insight as to what is actually being tested when viewing the Mode 6 data.

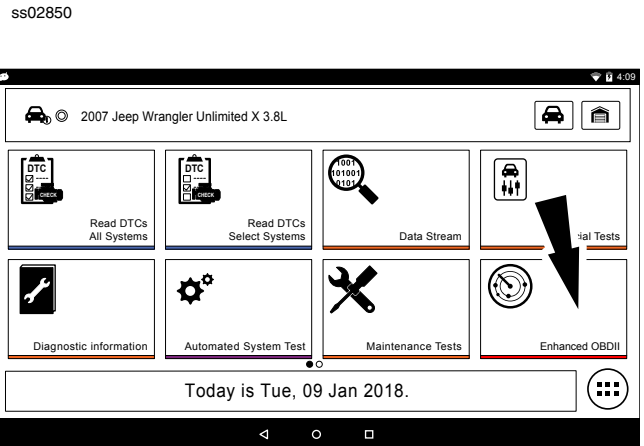

1. Select Enhanced OBDII from the screen.

Note: For more information refer to the OBDII section in the beginning of the manual.

## Saved Diagnostic Data

### Overview

The Saved Diagnostic Data functions allows the capability to recall previously run tests and Data Stream Records.

ss02847

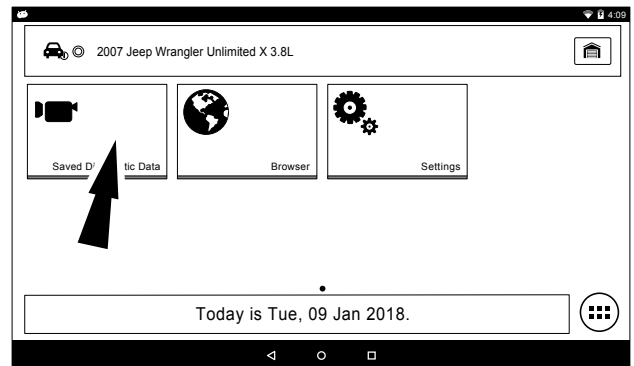

1. Select View Saved Tests from the Screen.

Note: For more information refer to the Saved Diagnostic section in the beginning of the manual.

# Browser

## Overview

An internet browser window is available for direct internet access.

ss02849

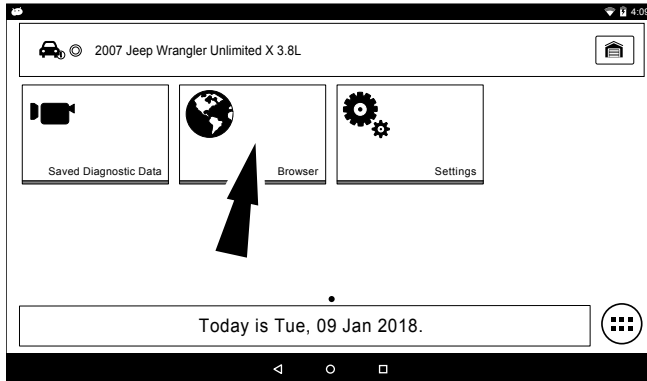

1. Select Browser from the Screen.

*Note: For more information refer to the Browser section in the beginning of the manual. Select the keyboard icon to input text.*

# Settings

## Overview

Select the settings icon to view and change handset default settings.

ss02851

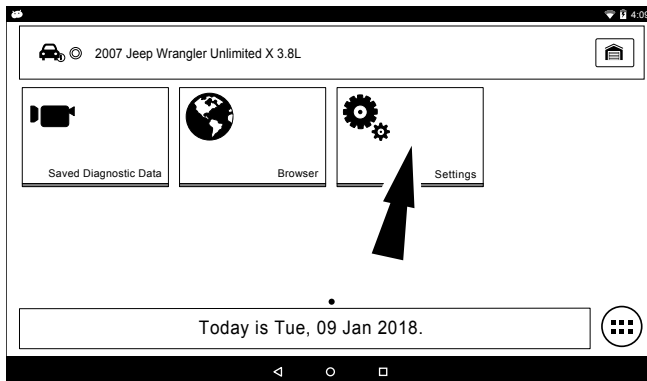

1. Select Settings from Screen

*Note: For more information refer to Setting section in the beginning of the manual.*

# Customer Support

## Order Information

Replacement and optional parts can be ordered from [www.otcparts.com](http://www.otcparts.com) or an OTC authorized tool supplier.

## Repair Service

Please contact Technical Support for troubleshooting and service options before sending any unit in for repair. To send a unit in for repair, go to <https://repairtrack.bosch-automotive.com> and follow the online instructions.

This website will also have the latest service policies and service center locations. If you do not have internet access, please call (800) 344-4013.

**Bosch**

Automotive Service Solutions Inc.

655 Eisenhower Drive  
Owatonna, MN 55060 USA  
Telephone: 507-455-7000

Customer Service (800) 533-6157

Fax (800) 283-8665

Technical Service (800) 533-6127

Fax (800) 955-8329

[www.otctools.com](http://www.otctools.com)